

---

**ONKYO**

AV RECEIVER

# TX-SR393DAB

Instruction Manual

Table of contents



Connections



- Connecting Speakers



Playback



Setup



Troubleshooting



Appendix



Supplementary Information



<b>What's in the box</b>	<b>4</b>
<b>Additional Function (Firmware Update)</b>	<b>5</b>
Update Information of the firmware	5
Operation of added new functions	5
Firmware Update Procedure	6
<b>Part Names</b>	<b>8</b>
Front Panel	8
Display	10
Rear Panel	11
Remote Controller	13
<b>Connections</b>	
<hr/>	
<b>Connecting speakers</b>	<b>15</b>
Speaker Installation	16
Speaker Connections and "Speaker Setup" Settings	21
Speaker combinations	25
<b>Connecting the TV</b>	<b>26</b>
To ARC TV	27
To Non-ARC TV	28
<b>Connecting Playback Devices</b>	<b>29</b>
Connecting an AV Component with HDMI Jack Mounted	29
Connecting an Audio Component	30

<b>Connecting an AV Component in a Separate Room (ZONE B Connection)</b>	<b>31</b>
Connecting a Pre-main Amplifier (ZONE B)	31
<b>Connecting Antennas</b>	<b>32</b>
<b>Connecting the Power Cord</b>	<b>33</b>
<b>Playback</b>	
<hr/>	
<b>AV Component Playback</b>	<b>35</b>
Basic Operations	35
<b>BLUETOOTH® Playback</b>	<b>36</b>
Basic Operations	36
<b>Listening To the FM Radio</b>	<b>37</b>
Tuning into a Radio Station	37
Presetting a Radio Station	39
Using RDS	41
<b>Listening To the DAB Digital Radio</b>	<b>42</b>
Basic Operations	42
<b>ZONE B Playback</b>	<b>44</b>
Playing Back	44
<b>Convenience functions</b>	<b>46</b>
Displaying Your Favorite Video on TV While Playing Music	46
Adjusting the tone	47
Sleep Timer	48

<b>Listening Mode</b>	<b>49</b>
Selecting a Listening mode	49
Speaker Layouts and Selectable Listening Modes	51
Listening Mode Effects	53
Input Formats and Selectable Listening Modes	57

## Setup

<b>Switching the HDMI 4K Signal Format Input and Output by this Unit</b>	<b>64</b>
<b>Setup Menu</b>	<b>65</b>
Menu list	65
Menu operations	67
1. Input/Output Assign	68
2. Speaker	71
3. Audio Adjust	74
4. Source	75
5. Hardware	77
6. Miscellaneous	80
<b>Quick Menu</b>	<b>81</b>
Menu operations	81
<b>Initial Setup with Auto Start-up Wizard</b>	<b>83</b>
Operations	83

## Troubleshooting

When the unit is operating erratically	86
Troubleshooting	87

## Appendix

<b>About HDMI</b>	<b>93</b>
<b>General Specifications</b>	<b>95</b>

## What's in the box

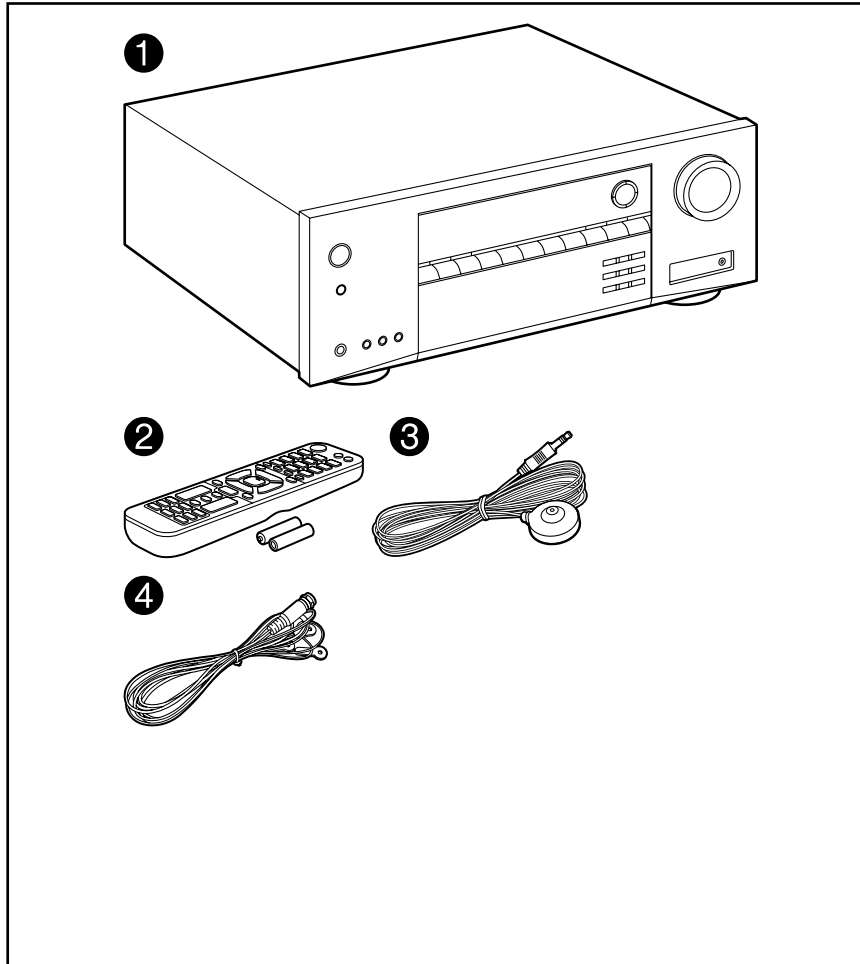

1. Main unit (1)
2. Remote controller (RC-970R) (1), Batteries (AAA/R03) (2)
3. Speaker setup microphone (1)
  - Used during Initial Setup.
4. DAB/FM antenna (1)
  - Initial Setup Guide (1)
  - \* This document is an online instruction manual. It is not included as an accessory.
  - Connect speakers with an impedance of 4  $\Omega$  to 16  $\Omega$ .
  - The power cord must be connected only after all other connections are completed.
  - We will not accept any responsibility for damage arising from the connection with equipment manufactured by other companies.
  - Specifications and appearance are subject to change without prior notice.

## Additional Function (Firmware Update)

This unit is equipped with a function to update the firmware via USB port when the firmware update is announced after purchase. This enables various functions to be added and operations to be improved.

Depending on the manufacturing timing of the product, the firmware may be switched to the updated one. In such a case, new functions may be added from the start. For how to confirm the latest firmware contents and the firmware version of your product, see the following section.

### Update Information of the firmware

For the latest firmware contents and the firmware version, visit our company's website. If the firmware version of your product differs from the latest one, it is recommended to update the firmware.

To confirm the firmware version of your product, press the ⚙ button on the remote controller, and refer to "6. Miscellaneous" - "Firmware Update" - "Version" ( →p80).

### Operation of added new functions

If functions are added or changed from contents described in the Instruction Manual, see the following reference.

[Supplementary Information](#) »

□ **Firmware Update Procedure ( →p6)**

## Firmware Update Procedure

Approx. 30 minutes are required for updating. Existing settings are kept after updating.

**Disclaimer:** The program and accompanying online documentation are furnished to you for use at your own risk.

Our company will not be liable and you will have no remedy for damages for any claim of any kind whatsoever concerning your use of the program or the accompanying online documentation, regardless of legal theory, and whether arising in tort or contract.

In no event will our company be liable to you or any third party for any special, indirect, incidental, or consequential damages of any kind, including, but not limited to, compensation, reimbursement or damages on account of the loss of present or prospective profits, loss of data, or for any other reason whatsoever.

### Updating the Firmware via USB

- While updating the firmware, do not do the following:
  - Disconnecting and reconnecting cables, USB storage device, speaker setup microphone or headphones, or performing operations on the unit such as turning the power off
- Prepare a 128 MB or larger USB storage device. The format of USB storage devices supports FAT16 or FAT32 file system format.
  - Media inserted into a USB card reader may not be used for this function.
  - USB storage devices equipped with the security function are not supported.
  - USB hubs and USB devices equipped with the hub function are not supported. Do not connect these devices to the unit.
- Delete any data stored on the USB storage device.
- If "HDMI CEC" is set to "On", set it to "Off".
  - Press . Next, select "5. Hardware" - "HDMI" and press ENTER, then select "HDMI CEC" and select "Off".
- \* Depending on the USB storage device or its content, long time may be required for loading, the content may not be loaded correctly, or power may not be supplied correctly.
- \* Our company will not be liable whatsoever for any loss or damage of data, or storage failure arising from the use of the USB storage device. Please note this in advance.
- \* The descriptions may differ from the actual on-screen displays, however, operations and functions are the same.

### Update

1. Connect the USB storage device to your PC.
2. Download the firmware file from the our company's website to your PC and unzip.

Firmware files are named as below.

ONKAVR\*\*\*\*\_\*\*\*\*\*.zip

Unzip the file on your PC. The number of unzipped files and folders varies depending on the model.

3. Copy all unzipped files and folders to the root folder of the USB storage device.
  - Make sure to copy the unzipped files.
4. Connect the USB storage device to the POWER OUT port of this unit.
  - If an AC adapter is supplied with the USB storage device, connect the AC adapter, and use it with a household outlet.
  - If the USB storage device has been partitioned, each section will be treated as an independent device.
5. Press .

The Setup menu is displayed on the TV screen.

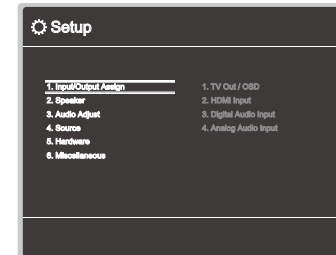

6. Select "6. Miscellaneous" - "Firmware Update" - "Update via USB" with the cursors in order, then press ENTER.

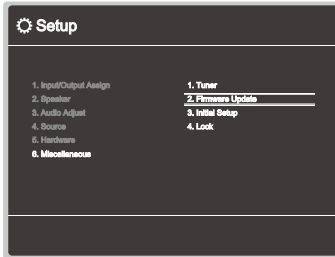

- If "Firmware Update" is grayed out and cannot be selected, wait for a while until it starts up.
7. Press ENTER with "Update" selected, and start update.
    - During the update, the TV screen may go black depending on the program to be updated. In such a case, check the progress on the display of the unit. The TV screen will remain black until the update is completed and the power is turned on again.
    - During the update, do not turn the power off, or disconnect or reconnect the USB storage device.
    - When "Completed!" is displayed, the update is complete.
  8. Disconnect the USB storage device from the unit.
  9. Press  $\odot$  ON/STANDBY on the main unit to turn the unit into standby mode. The process is completed, and your firmware is updated to the latest version.
    - Do not use  $\odot$  on the remote controller.

### If an Error Message is Displayed

If an error occurs, "Error! \*-\*\*" is displayed on the display of the unit. ("\*" represents an alphanumeric character.) Refer to the following descriptions and check.

#### Error Code

- \*-70:  
The USB storage device cannot be recognized, the firmware file is not present in the root folder of the USB storage device, or the firmware file is for another model. Check if the USB storage device or USB cable is securely inserted to the POWER OUT port of the unit.

Connect the USB storage device to an external power source if it has its own power supply.

- \*-51:  
The firmware file is for another model, or the firmware file is corrupted. Retry from the download of the firmware file.
- Others:  
After removing the power plug once, insert it to the outlet, and then start the operation from the beginning.

## Part Names

### Front Panel

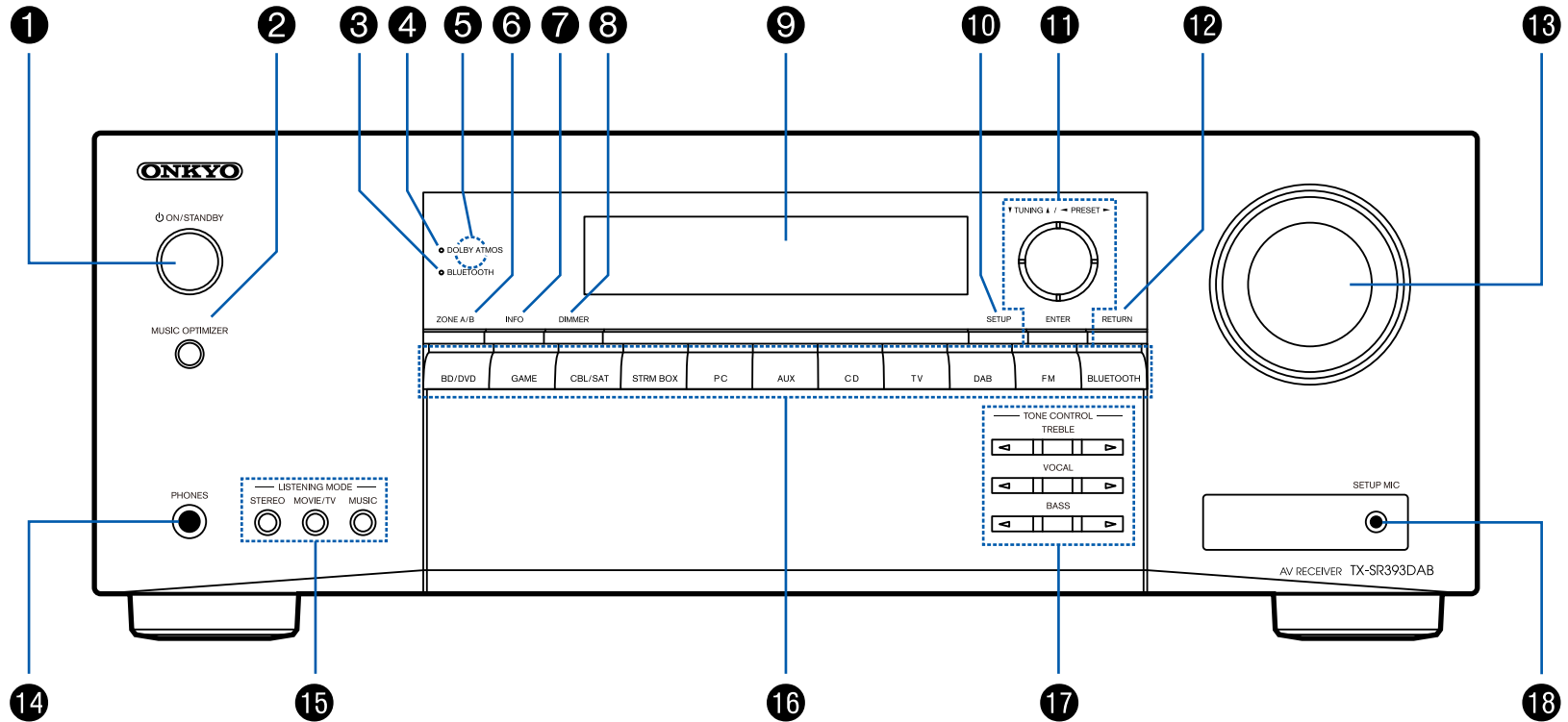

□ For details, see ( →p9)



1.  $\phi$  ON/STANDBY button
2. MUSIC OPTIMIZER button: Turns on/off the MUSIC OPTIMIZER function that improves the quality of the compressed audio.
3. BLUETOOTH indicator: Lights up when this unit and a BLUETOOTH-enabled device are connected.
4. DOLBY ATMOS indicator: Lights up when Dolby Atmos signals are reproduced in appropriate listening mode.
5. Remote control sensor: Receives signals from the remote controller.
  - The reception range of the remote controller is within a distance of approx. 16'5 m, and an angle of 20° in vertical direction and 30° to right and left.
6. ZONE A/B button: Selects an audio output destination from among "ZONE A", "ZONE B" and "ZONE A+B". (→[p44](#))
7. INFO button: Switches the information on the display and is used to operate RDS (→[p41](#)).
8. DIMMER button: Switches the brightness of the display with three levels. It cannot be turned off completely.
9. Display (→[p10](#))
10. SETUP button: You can display advanced setting items on the TV and the display to have a more enjoyable experience with this unit. (→[p65](#))
11. Cursor buttons ( $\blacktriangle$  /  $\blacktriangledown$  /  $\blacktriangleleft$  /  $\blacktriangleright$ ) and ENTER button: Select an item with the cursors, and press ENTER to confirm your selection. When using TUNER, use them to tune in to stations. (→[p37](#))
12. RETURN button: Returns the display to the previous state while setting.
13. MASTER VOLUME
14. PHONES jack: Connect headphones with a standard plug ( $\phi 1/4"/6.3$  mm).
15. LISTENING MODE button: Switches the listening mode (→[p49](#)) by pressing "STEREO", "MOVIE/TV" and "MUSIC" repeatedly.
16. Input selector buttons: Switches the input to be played.
17. TONE CONTROL button: Adjusts the sound quality. Press  $\blacktriangleleft$  /  $\blacktriangleright$  of "TREBLE", "VOCAL" or "BASS" respectively. (→[p47](#))
18. SETUP MIC jack: Connect the supplied speaker setup microphone. (→[p84](#))

## Display

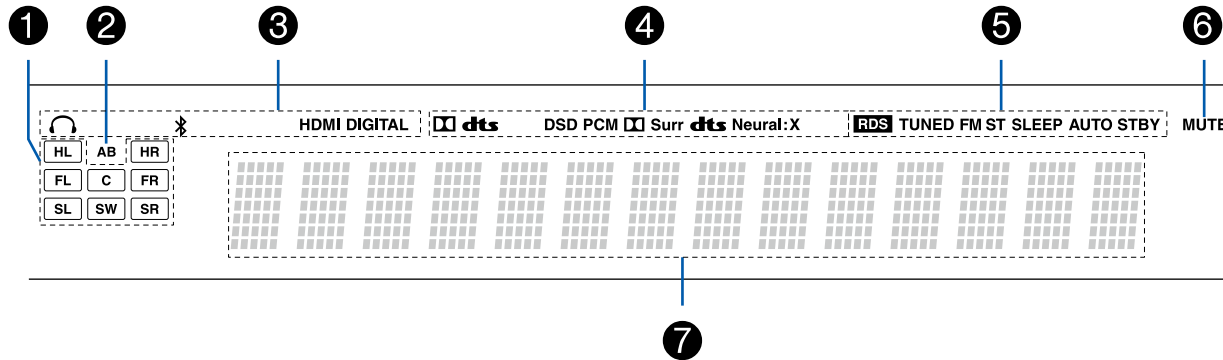

1. Speaker/Channel display: Displays the output channel that corresponds to the selected listening mode.
2. Displays the audio output destination.
  - A: Outputs audio only to the main room (ZONE A).
  - B: Outputs audio only to the separate room (ZONE B).
  - AB: Outputs audio to both the main room (ZONE A) and separate room (ZONE B).
3. Lights in the following conditions.
  - 🎧: Headphones are connected.
  - 📶: Connected by BLUETOOTH.
  - HDMI: HDMI signals are input and the HDMI input is selected.
  - DIGITAL: Digital signals are input and the digital input is selected.
4. Lights according to the type of input digital audio signal and the listening mode.
5. Lights in the following conditions.
  - RDS: Receiving RDS broadcasting.
  - TUNED: Receiving DAB/FM radio.
  - FM ST: Receiving FM stereo.
  - SLEEP: Sleep timer is set. (→[p79](#))
  - AUTO STBY: Auto Standby is set. (→[p79](#))
6. Blinks when muting is on.
7. Displays various information of the input signals.

## Rear Panel

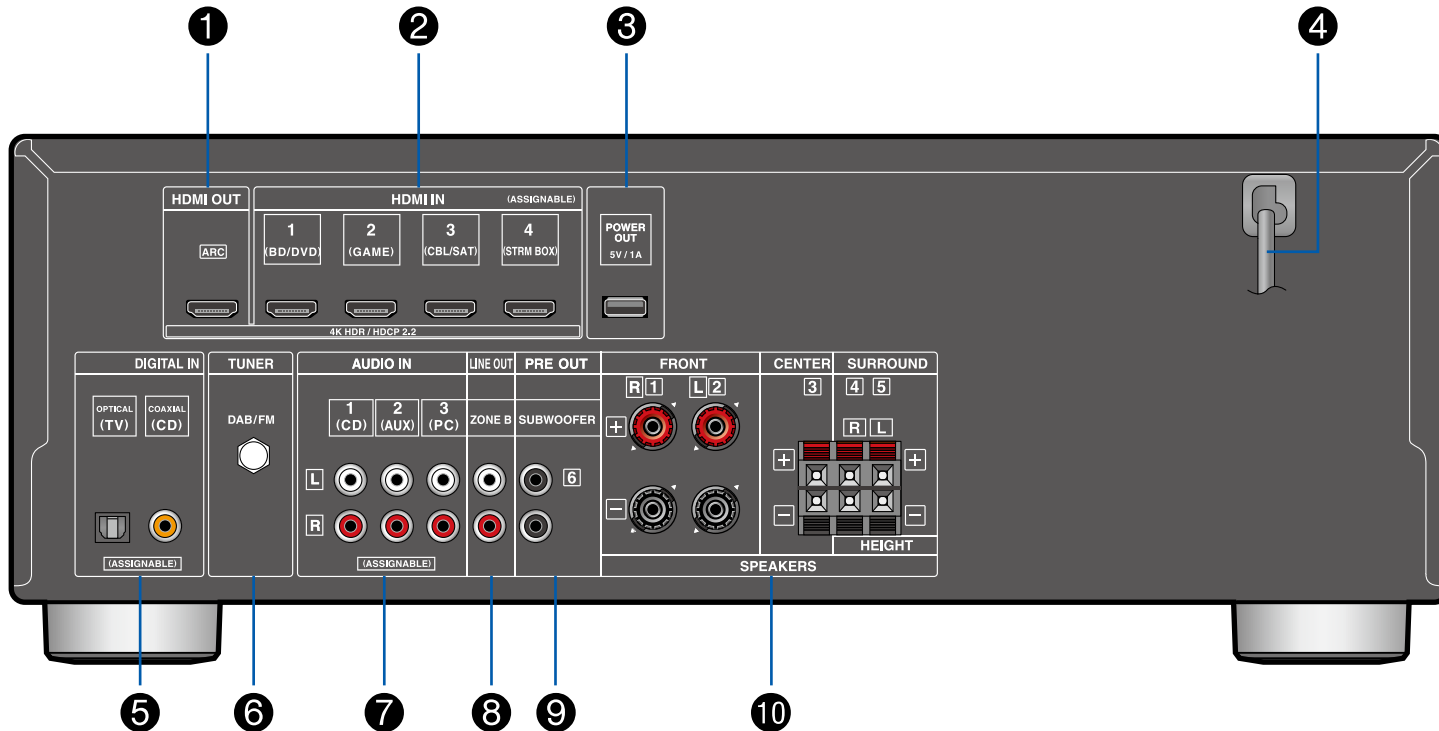

□ For details, see ( →[p12](#))

1. HDMI OUT jacks: Transmit video signals and audio signals with an HDMI cable connected to a TV.
2. HDMI IN jacks: Transmit video signals and audio signals with an HDMI cable connected to an AV component.
3. POWER OUT port: You can also supply power (5 V/1 A) to the Streaming media player connected to the HDMI IN terminal of this unit with a USB cable. (→[p29](#)) The playback function of music files and power supply to smart phones/tablets, or other devices are not supported.
4. Power cord
5. DIGITAL IN OPTICAL/COAXIAL jacks: Input TV or AV component digital audio signals with a digital optical cable or digital coaxial cable.
6. TUNER DAB/FM terminal: Connect the supplied antennas.
7. AUDIO IN jacks: Input TV or AV component audio signals with an analog audio cable.
8. ZONE B LINE OUT jacks: Output audio signals with an analog audio cable connected to a pre-main amplifier in a separate room (ZONE B).
9. SUBWOOFER PRE OUT jacks: Connect a powered subwoofer with a subwoofer cable. Up to two powered subwoofers can be connected. The same signal is output from each SUBWOOFER PRE OUT jack.
10. SPEAKERS terminals: Connect speakers with speaker cables.

## Remote Controller

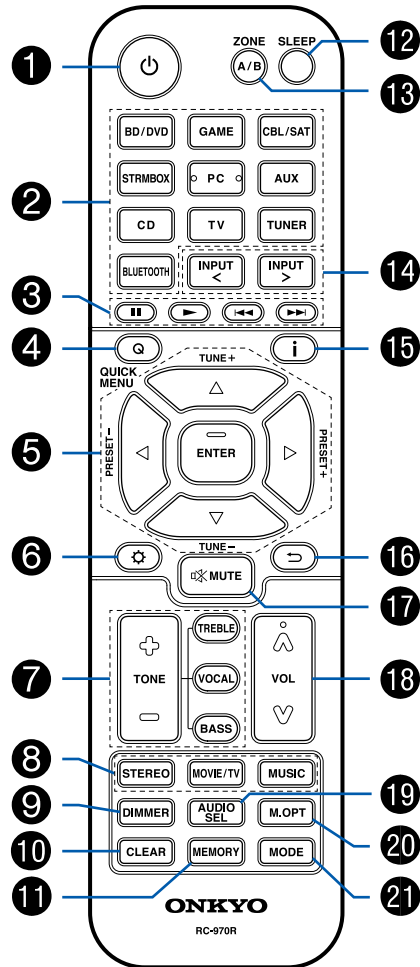

1. **ON/STANDBY button**
2. **Input selector buttons:** Switches the input to be played.
3. **Play buttons:** Used for playback operation of a BLUETOOTH-enabled device. If the unit is switched to "CEC MODE" using the MODE button, an HDMI CEC function-enabled AV component can be operated. (Depending on the device, operation may not be possible.)
4. **Q (QUICK MENU) button:** Pressing this button during playback can make settings such as "HDMI" and "Audio" quickly on the TV screen while playing. (→p81)
5. **Cursor buttons and ENTER button:** Select an item with the cursors, and press ENTER to confirm your selection.
6. **Settings button:** Display advanced setting items on the TV or the display to have a more enjoyable experience with this unit. (→p65)
7. **TONE button:** Adjusts the sound quality. (→p47)
8. **LISTENING MODE button:** Select a listening mode (→p49).
9. **DIMMER button:** Switches the brightness of the display with three levels. It cannot be turned off completely.
10. **CLEAR button:** Deletes all characters you have entered when entering text on the TV screen.
11. **MEMORY button:** Used to register radio stations. (→p39)
12. **SLEEP button:** Set the sleep timer. Select the time from "30 min", "60 min" and "90 min". (→p48)
13. **ZONE A/B button:** Selects an audio output destination from among "ZONE A", "ZONE B" and "ZONE A+B". (→p44)
14. **Input selector cursors:** Switches the input to be played.
15. **i button:** Switches the information on the display and is used to operate RDS (→p41).
16. **RETURN button:** Returns the display to the previous state while setting.
17. **MUTE button:** Temporarily mutes audio. Press the button again to cancel muting.
18. **VOLUME buttons**
19. **AUDIO SEL button:** When a device is connected to two or more audio input terminals for one input selector, you can select which audio input signal to play.
20. **M.OPT button:** Turns on/off the MUSIC OPTIMIZER function that improves the quality of the compressed audio.
21. **MODE button:** Switches between automatic tuning and manual tuning for FM stations (→p37). Also, when an HDMI CEC function-enabled AV component is connected to this unit, you can switch "3. Play buttons" between "CEC MODE" and "RCV MODE" (normal mode).

## **Connections**

---

<b>Connecting speakers</b>	<b>15</b>
<b>Connecting the TV</b>	<b>26</b>
<b>Connecting Playback Devices</b>	<b>29</b>
<b>Connecting an AV Component in a Separate Room (ZONE B Connection)</b>	<b>31</b>
<b>Connecting Antennas</b>	<b>32</b>
<b>Connecting the Power Cord</b>	<b>33</b>

## Connecting speakers

You can select the layout of speakers to be installed from various patterns when using this unit. Use the following flow chart to select the speaker layout that suits your speakers and usage environment. You can check the connection method and default settings.

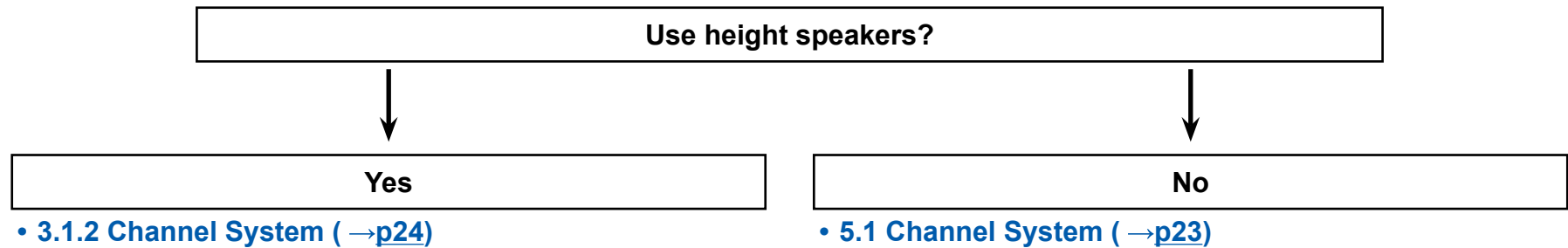

## Speaker Installation

### ■ 5.1 Channel System

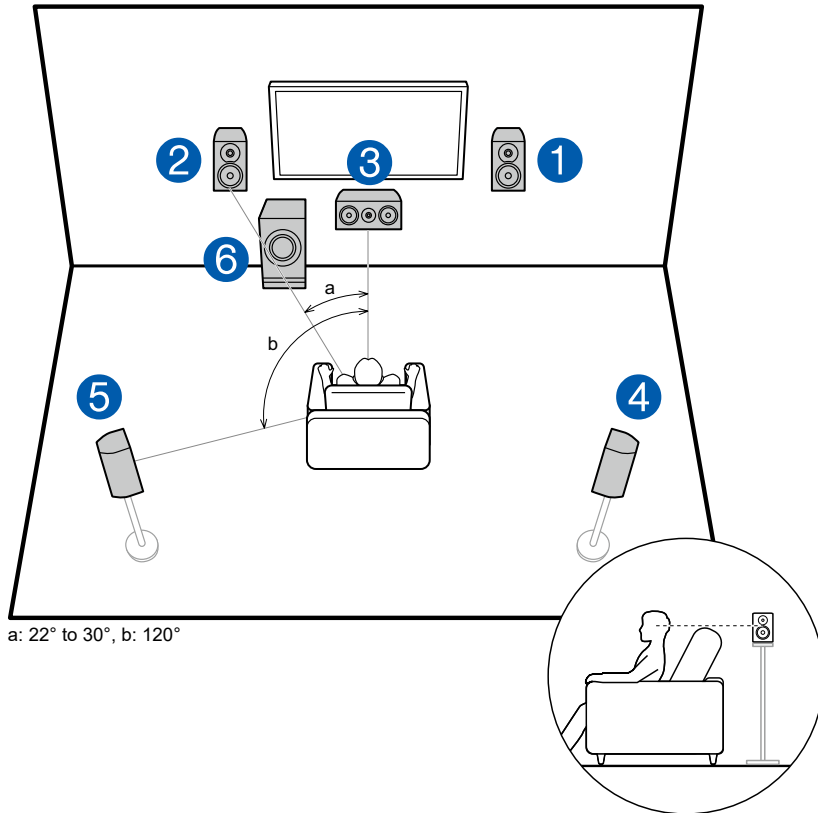

This is a basic 5.1 Channel System. Front speakers output the front stereo sound, and a center speaker outputs the sound of the center of the screen, such as dialogs and vocals. Surround speakers create the back sound field. Powered subwoofer reproduces the bass sound, and creates the rich sound field. The front speakers should be positioned at ear height while the surround speakers should be positioned just above ear height. The center speaker should be set up facing the listening position at an angle. Placing the powered subwoofer between the center speaker and the front speaker gives you a natural sound even when playing music sources.

- 1,2 Front Speakers
- 3 Center Speaker
- 4,5 Surround Speakers
- 6 Powered Subwoofer

□ **Speaker Layouts and Selectable Listening Modes ( →[p51](#))**



### ■ 3.1.2 Channel System

A 3.1.2 Channel System is a speaker layout consisting of a 3.1 Channel System that includes front speakers, center speaker and powered subwoofer, and added height speakers. Select the height speakers that suit your speakers and usage environment from the following three types.

- Front High Speakers Installation Example**  
( →[p18](#))
- Ceiling Speakers Installation Example**  
( →[p19](#))
- Dolby Enabled Speakers (Dolby Speakers) Installation Example** ( →[p20](#))

## □ Front High Speakers Installation Example

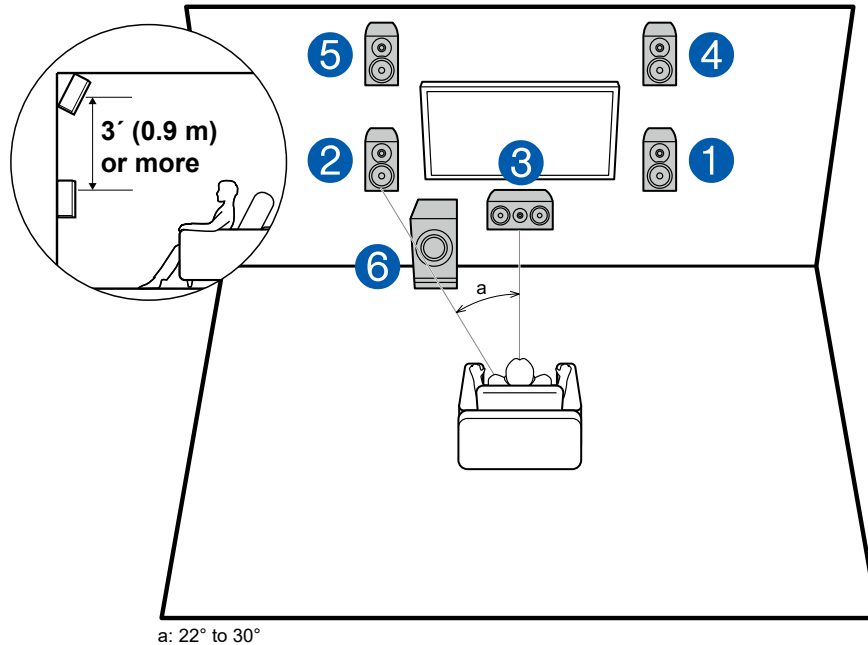

a: 22° to 30°

This is a 3.1-channel system consisting of front speakers, a center speaker, and a powered subwoofer, with the addition of front high speakers, a type of height speaker. Installing the height speakers will enrich the sound field feeling in the upper space. Front high speakers should be situated at least 3'/0.9 m higher than the front speakers.

They should also be put directly above the front speakers, angled to face the listening position.

- 1,2 Front Speakers
- 3 Center Speaker
- 4,5 Front High Speakers
- 6 Powered Subwoofer

## □ Speaker Layouts and Selectable Listening Modes ( →[p51](#))

## ❑ Ceiling Speakers Installation Example

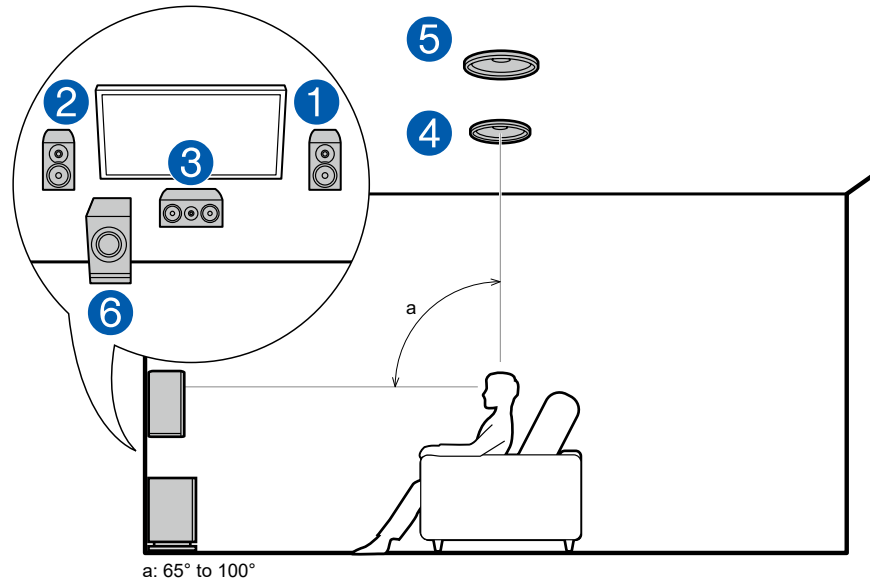

This is a 3.1-channel system consisting of front speakers, a center speaker, and a powered subwoofer, with the addition of top middle speakers, a type of height speaker. Installing the height speakers will enrich the sound field feeling in the upper space. Fit top middle speakers on the ceiling directly above the listening position. The distance between each pair should match the distance between the two front speakers.

- Dolby Laboratories recommends the setups of these types of height speakers to obtain the best Dolby Atmos effect.

- 1,2 Front Speakers
- 3 Center Speaker
- 4,5 Top Middle Speakers
- 6 Powered Subwoofer

## ❑ Speaker Layouts and Selectable Listening Modes ( →[p51](#))

❑ **Dolby Enabled Speakers (Dolby Speakers)  
Installation Example**

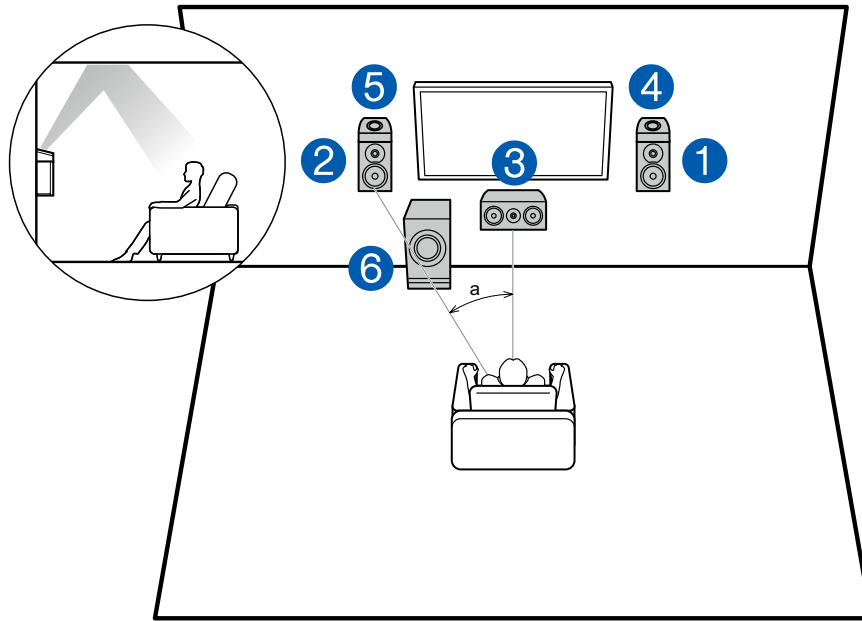

a: 22° to 30°

This is a 3.1-channel system consisting of front speakers, a center speaker, and a powered subwoofer, with the addition of Dolby enabled speakers (front), a type of height speaker. Dolby enabled speakers are special speakers designed to face the ceiling, so that the sound is heard from overhead by bouncing the sound off the ceiling. Installing the height speakers will enrich the sound field feeling in the upper space.

Place Dolby enabled speakers (front) above the front speakers.

- 1,2 Front Speakers
- 3 Center Speaker
- 4,5 Dolby Enabled Speakers (Front)
- 6 Powered Subwoofer

❑ **Speaker Layouts and Selectable Listening Modes ( →[p51](#))**

## Speaker Connections and "Speaker Setup" Settings

### Connections

#### ■ (Note) Speaker Impedance

Connect speakers with an impedance of 4 Ω to 16 Ω. If any of the speakers to be connected has an impedance of 4 Ω or more and less than 6 Ω, set "Speaker Impedance" to "4 ohms" for "Speaker Setup" in the Initial Setup section (→p83). When setting "Speaker Impedance" from the Setup menu, press ⌘ on the remote controller, and set "2. Speaker" - "Configuration" - "Speaker Impedance" (→p71) to "4 ohms".

#### ■ Connect the Speaker Cables

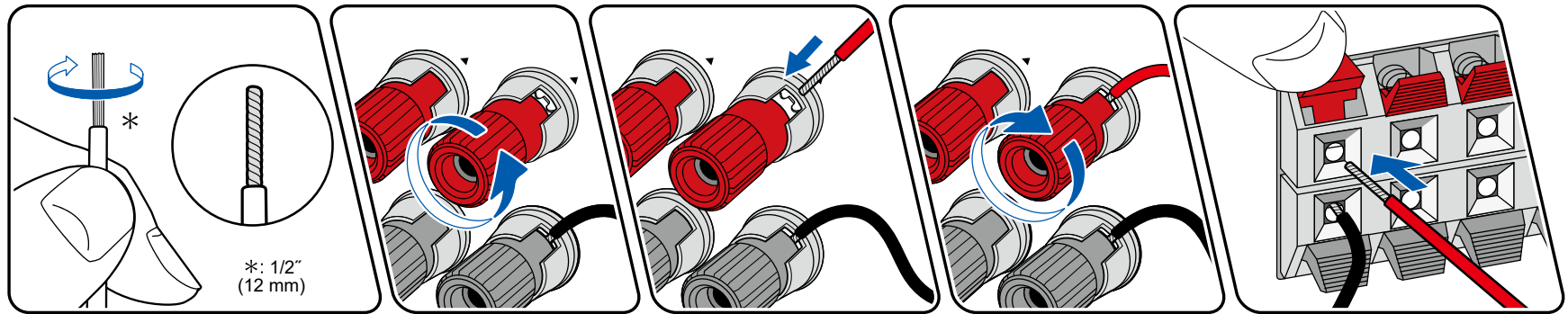

Make correct connection between the unit's jacks and speaker's jacks (+ side to + side, and - side to - side) for each channel. If the connection is wrong, a bass sound will not be reproduced properly due to reverse phase. Twist the wires exposed from the tip of the speaker cable so that the wires do not stick out of the speaker terminal when connecting. If the exposed wires touch the rear panel, or the + side and - side wires touch each other, a malfunction may occur.

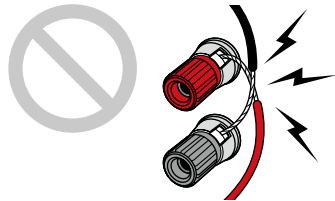

## ■ Connect the Subwoofer

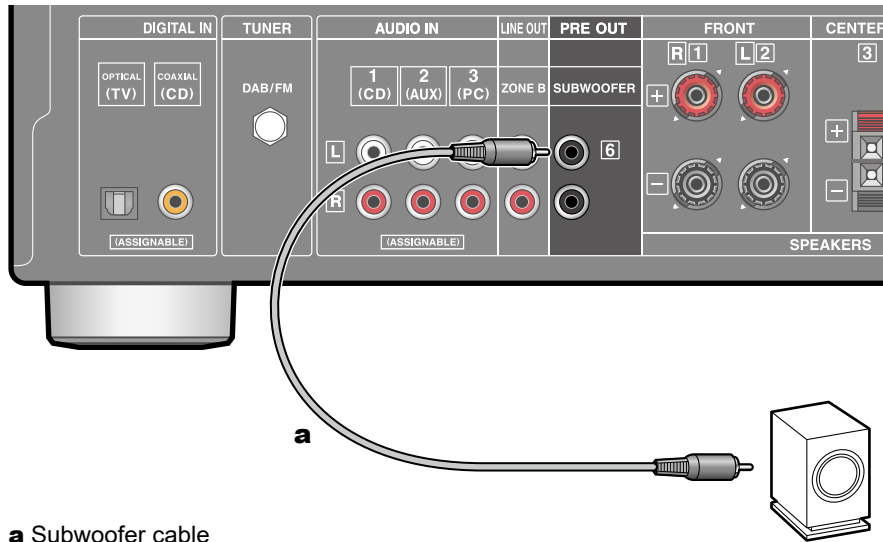

### **a** Subwoofer cable

Connect a powered subwoofer with this unit using a subwoofer cable. Up to two powered subwoofers can be connected. The same signal is output from each SUBWOOFER PRE OUT jack.

## ■ 5.1 Channel System

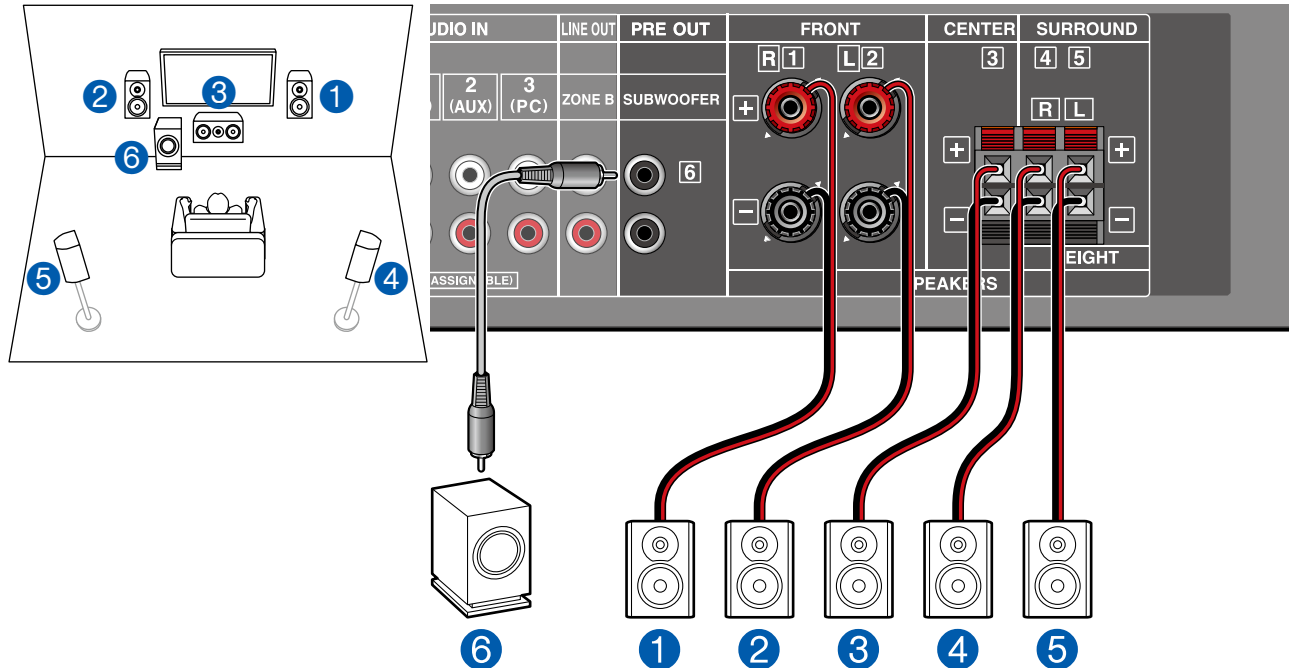

This is a basic 5.1 Channel System. For details of the speaker layout, refer to "Speaker Installation" (→p16).

### ■ "Speaker Setup" settings during Initial Setup (→p84)

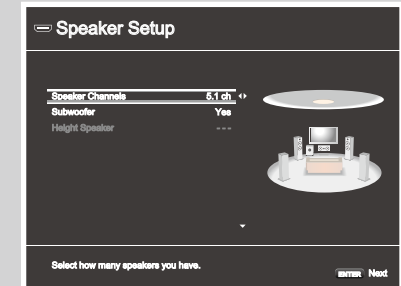

- Speaker Channels: 5.1 ch
- Subwoofer: Yes
- Height Speaker: ---
- Speaker Impedance: Set any value (→p21)

### ■ 3.1.2 Channel System

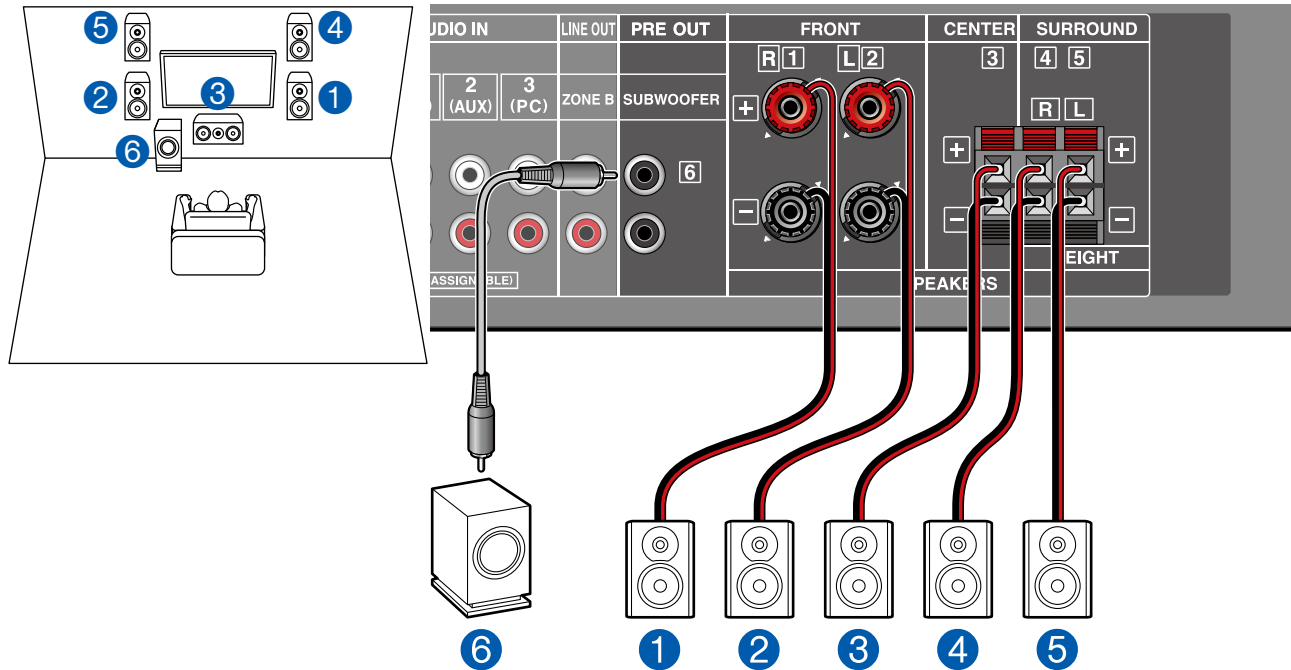

This is a combination of the 3.1 Channel System and front high speakers. A front high speaker is a type of height speaker. You can select only one set of height speakers from the following three types for connection.

- Front High Speakers Installation Example ( →p18)
- Ceiling Speakers Installation Example ( →p19)
- Dolby Enabled Speakers (Dolby Speakers) Installation Example ( →p20)

#### ■ "Speaker Setup" settings during Initial Setup ( →p84)

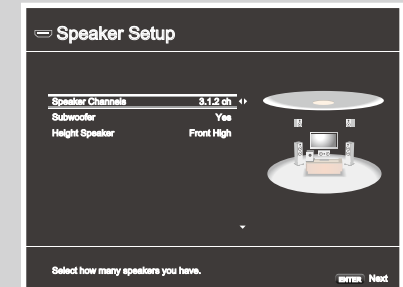

- Speaker Channels: 3.1.2 ch
- Subwoofer: Yes
- Height Speaker: Select the type of height speaker actually installed.
- Speaker Impedance: Set any value ( →p21)



## Speaker combinations

- Up to two powered subwoofers can be connected in either combination.

Speaker Channels	FRONT	CENTER	SURROUND	HEIGHT
2.1 ch	✓			
3.1 ch	✓	✓		
4.1 ch	✓		✓	
5.1 ch	✓	✓	✓	
2.1.2 ch	✓			✓
3.1.2 ch	✓	✓		✓

## Connecting the TV

Connect this unit between a TV and AV component. Connecting this unit with the TV can output the video and audio signals of the AV component to the TV, or play the audio of the TV on this unit. Connection with the TV differs depending on whether the TV supports the ARC (Audio Return Channel) function or not. The ARC function transmits the audio signals of the TV via an HDMI cable, and plays the audio of the TV on this unit. To check if the TV supports the ARC function, refer to the instruction manual of the TV, etc.

Does your TV support the ARC function?

Yes

• To ARC TV ( →[p27](#))

No

• To Non-ARC TV ( →[p28](#))

## To ARC TV

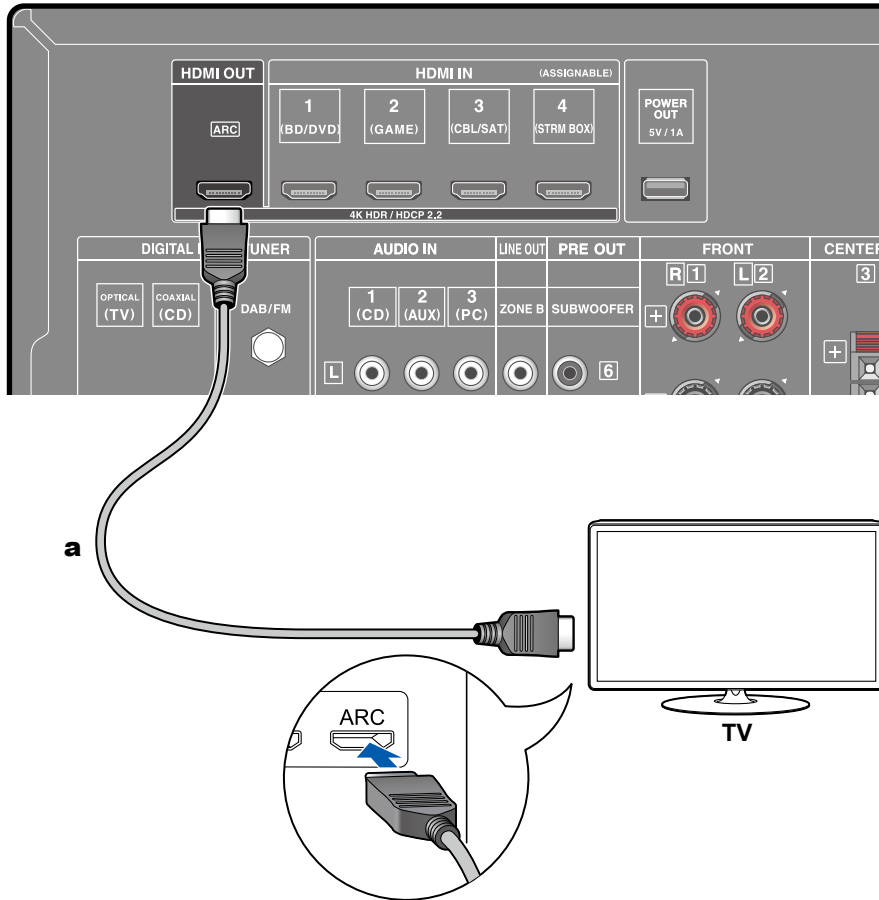

**a** HDMI cable

If the TV supports the ARC (Audio Return Channel) function (\*), use only the HDMI cable to connect with the TV. Use the ARC-compatible HDMI IN jack of the TV for connection. You connect the HDMI cable to the port labeled OUT on the receiver side.

- If a 4K high-quality video is played, use a Premium High Speed HDMI Cable or Premium High Speed HDMI Cable with Ethernet whose package has a "PREMIUM Certified Cable" label. Furthermore, in "Switching the HDMI 4K Signal Format Input and Output by this Unit" (→[p64](#)), change the setting value to "Enhanced".



### Setup

- Settings are required to use the ARC function. Select "Yes" for "3. ARC Setup" in Initial Setup (→[p83](#)). If "No, Skip" is selected, settings are required in the Setup menu after Initial Setup is completed. Press  on the remote controller, and set "5. Hardware" - "HDMI" - "Audio Return Channel" to "On". (→[p78](#))
- For detailed settings for TV connection, CEC function and audio output, refer to the instruction manual of the TV.

(\*) ARC function: This function transmits the audio signals of the TV via an HDMI cable, and plays the audio of the TV on this unit. Connection to an ARC-compatible TV is complete with one HDMI cable. To check if the TV supports the ARC function, refer to the instruction manual of the TV, etc.

## To Non-ARC TV

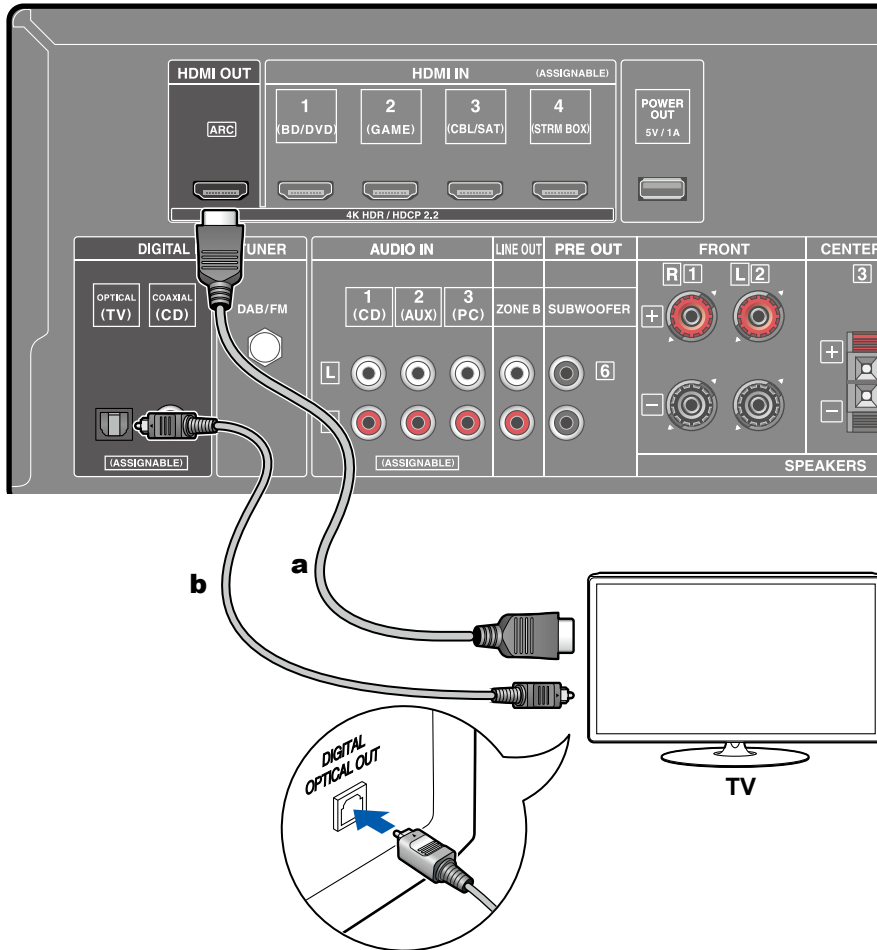

**a** HDMI cable, **b** Digital optical cable

If the TV does not support the ARC (Audio Return Channel) function (\*), connect an HDMI cable and digital optical cable.

- If you use a cable set-top box, etc. connected to the input jack of this unit to watch TV (without using a TV's built-in tuner), connection with a digital optical cable or analog audio cable is not required.
- If a 4K high-quality video is played, use a Premium High Speed HDMI Cable or Premium High Speed HDMI Cable with Ethernet whose package has a "PREMIUM Certified Cable" label. Furthermore, in "Switching the HDMI 4K Signal Format Input and Output by this Unit" (→[p64](#)), change the setting value to "Enhanced".

(\*) ARC function: This function transmits the audio signals of the TV via an HDMI cable, and plays the audio of the TV on this unit. Connection to an ARC-compatible TV is complete with one HDMI cable. To check if the TV supports the ARC function, refer to the instruction manual of the TV, etc.

## Connecting Playback Devices

### Connecting an AV Component with HDMI Jack Mounted

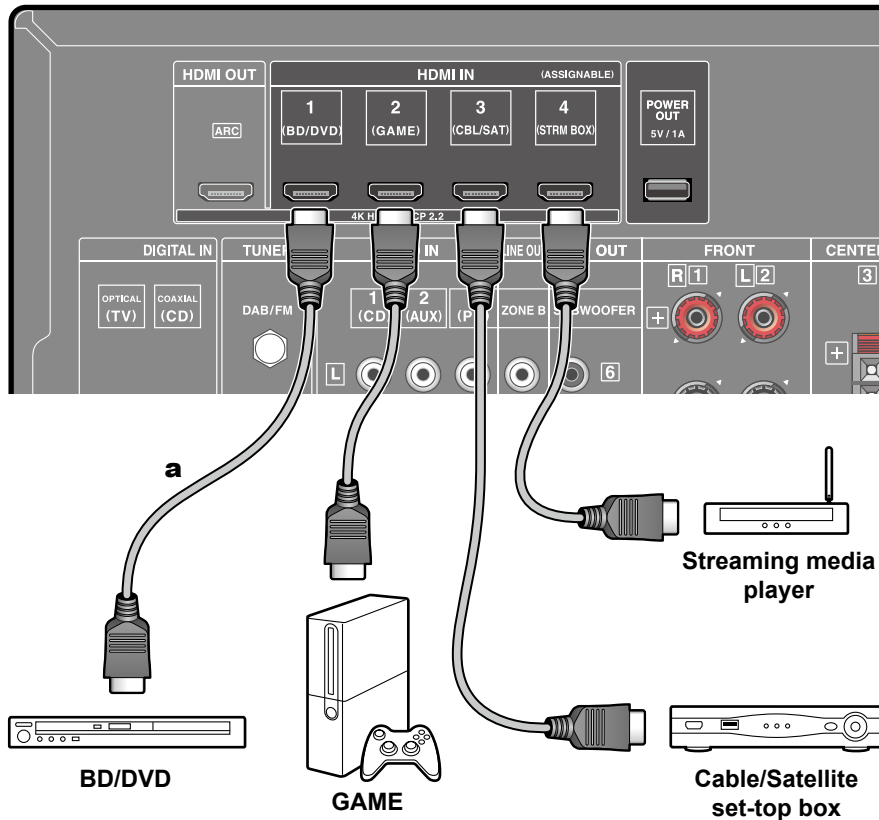

**a** HDMI cable

This is a connection example of an AV component equipped with an HDMI jack. When connecting with an AV component that conforms to the CEC (Consumer Electronics Control) standard, you can use the HDMI CEC function (\*) that enables linking with input selectors, etc. and the HDMI Standby Through function that can transmit video and audio signals of the AV component to the TV even if this unit is in standby mode. Also, the POWER OUT jack on the rear panel can supply power (5 V/1 A) to a streaming media player connected to HDMI IN jack of this unit. To supply power even when this unit is in standby mode, change the setting value of "USB Power Out at Standby" (→p79) to "On".

- If a 4K high-quality video is played, use a Premium High Speed HDMI Cable or Premium High Speed HDMI Cable with Ethernet whose package has a "PREMIUM Certified Cable" label. Furthermore, in "Switching the HDMI 4K Signal Format Input and Output by this Unit" (→p64), change the setting value to "Enhanced".
- The POWER OUT jack cannot support playback of music files or power supply to smart phones/tablets, or other devices.



#### Setup

- The HDMI CEC function and HDMI Standby Through function are automatically enabled if you select "Yes" for "3. ARC Setup" in Initial Setup (→p83). If "No, Skip" is selected, settings are required in the Setup menu after Initial Setup is completed. Press  on the remote controller, and select "5. Hardware" - "HDMI" to make the settings. (→p77)
- To enjoy digital surround sound including Dolby Digital, set the audio output of the connected Blu-ray Disc player etc. to the Bitstream output.

(\*)The HDMI CEC function: This function enables various linking operations with CEC-compliant devices, such as switching input selectors interlocking with a CEC-compliant player, switching audio output between TV and this unit or adjusting the volume using the remote controller of a CEC-compliant TV, and automatically switching this unit to standby when the TV is turned off.

## Connecting an Audio Component

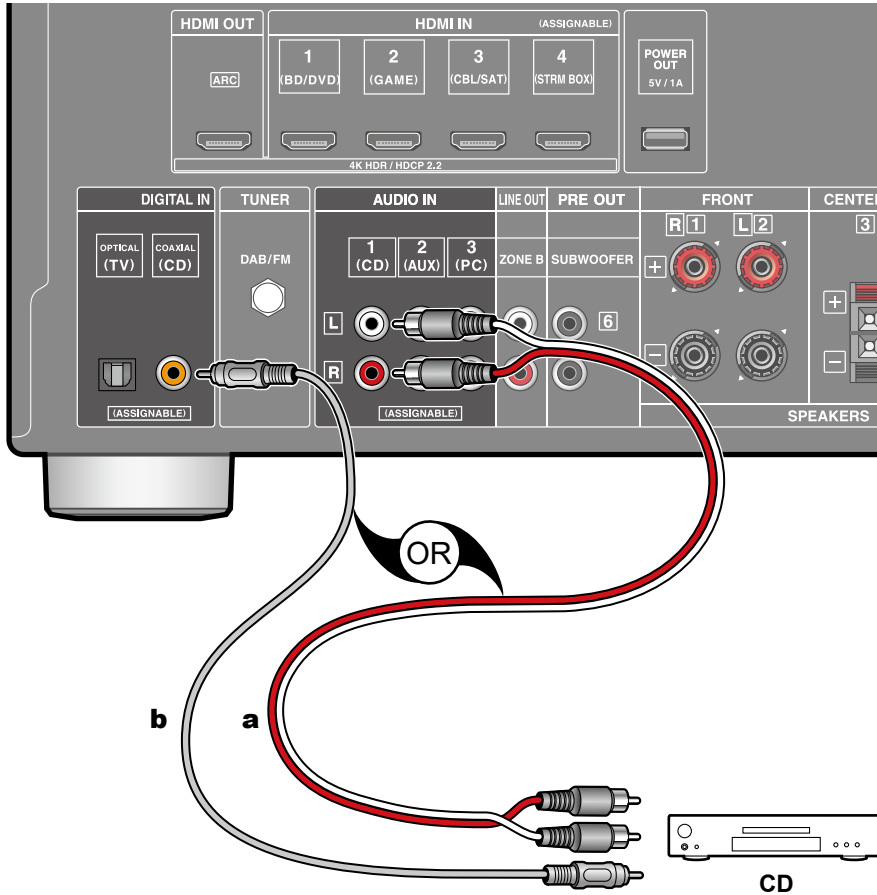

This is a connection example of an audio component. Connect a CD player using a digital coaxial cable or analog audio cable.

**a** Analog audio cable, **b** Digital coaxial cable

## Connecting an AV Component in a Separate Room (ZONE B Connection)

### Connecting a Pre-main Amplifier (ZONE B)

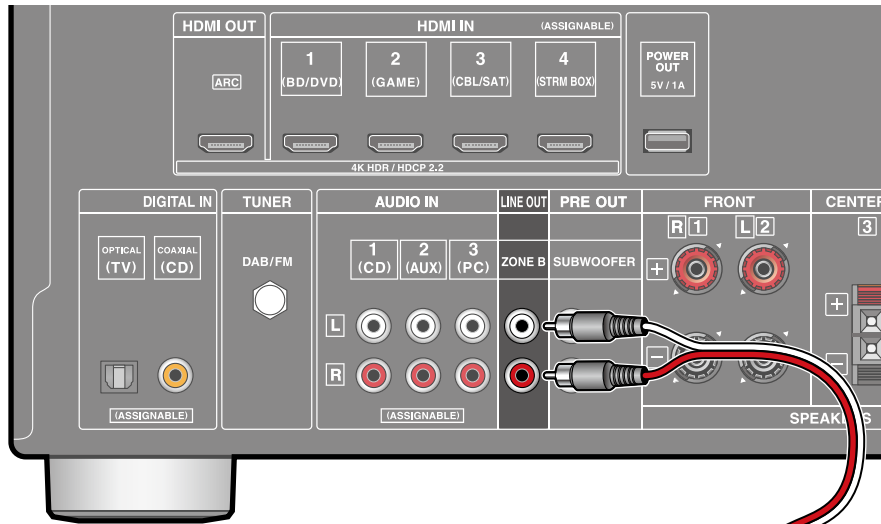

While performing playback in the main room (ZONE A), you can enjoy 2-ch audio of the same source in the separate room (ZONE B) at the same time. Use an analog cable to connect the ZONE B LINE OUT jack of this unit and the LINE IN jack of the pre-main amplifier in the separate room.

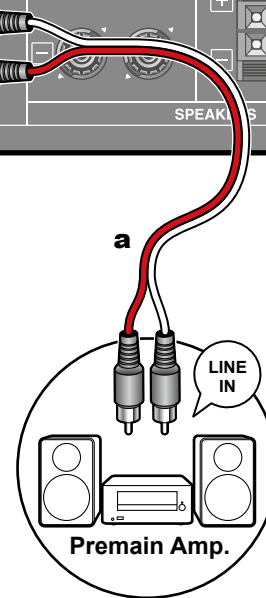

**a** Analog audio cable

## Connecting Antennas

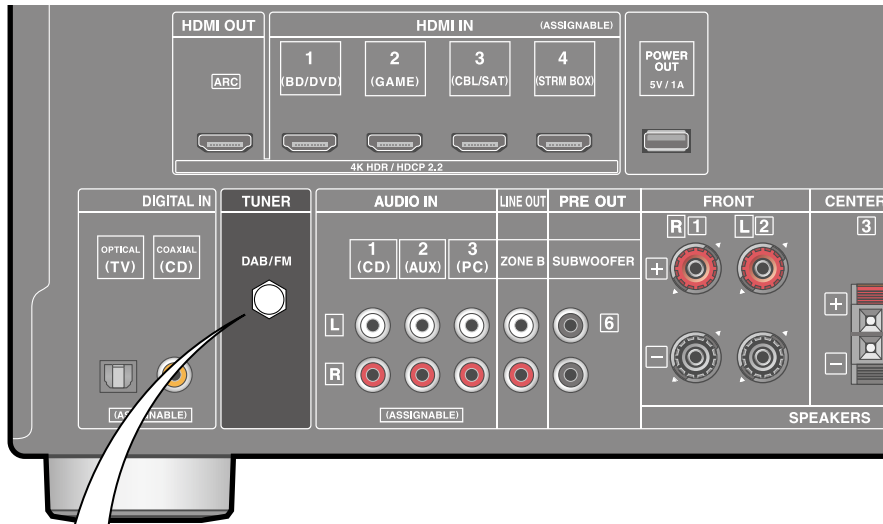

Make sure the plug is pushed in all the way, then fix in place by turning the nut to the right. Use a tack or similar to fix the antenna to a wall.

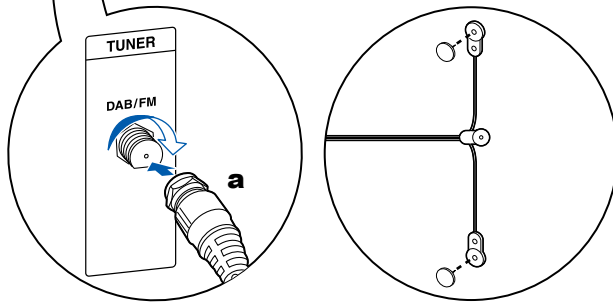

**a** DAB/FM antenna



## Connecting the Power Cord

Connect the power cord after all the connections are completed.

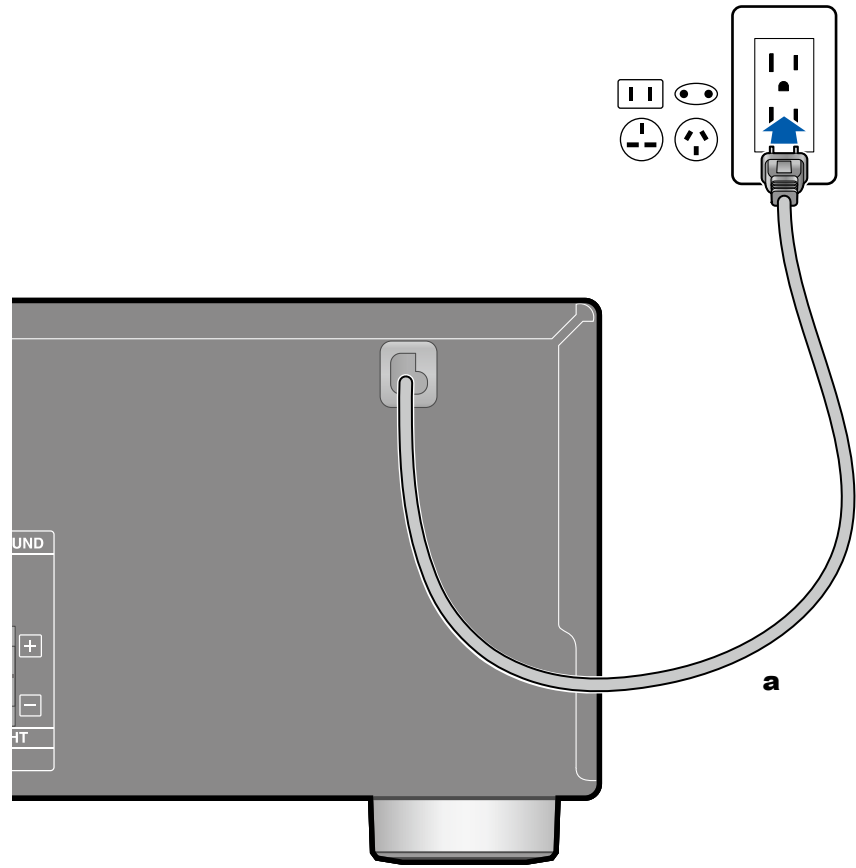

**a** Power cord

## **Playback**

---

<b>AV Component Playback</b>	<b>35</b>
<b>BLUETOOTH® Playback</b>	<b>36</b>
<b>Listening To the FM Radio</b>	<b>37</b>
<b>Listening To the DAB Digital Radio</b>	<b>42</b>
<b>ZONE B Playback</b>	<b>44</b>
<b>Convenience functions</b>	<b>46</b>
<b>Listening Mode</b>	<b>49</b>

## AV Component Playback

You can play the audio from AV components, such as Blu-ray disc players through this unit.

### Basic Operations

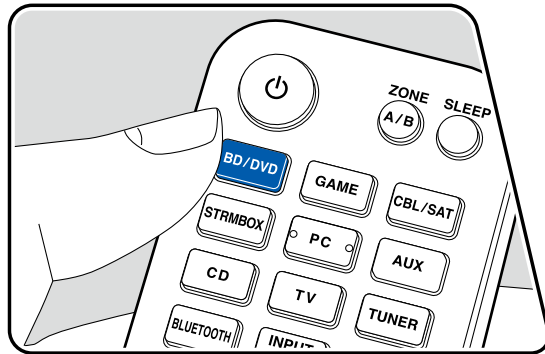
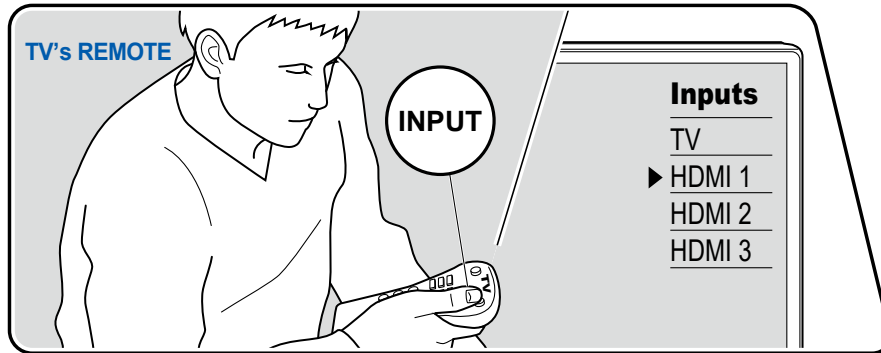

Perform the following procedure when this unit is on.

1. Switch the input on the TV to the input connected to the unit.
2. Press the input selector whose name is the same as that of the jack to which the player is connected.  
For example, press BD/DVD to play the player connected to the BD/DVD jack.  
Press TV to listen the sound of the TV.
  - When the CEC link function works, the input switches automatically when a CEC compliant TV or player is connected to this unit using HDMI connection.
3. Start play on the AV component.

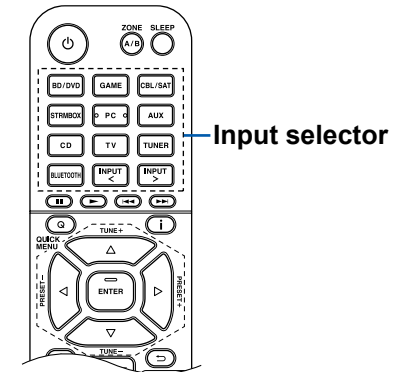

## BLUETOOTH® Playback

You can wirelessly play the audio on a BLUETOOTH-enabled device, such as a smartphone.

### Basic Operations

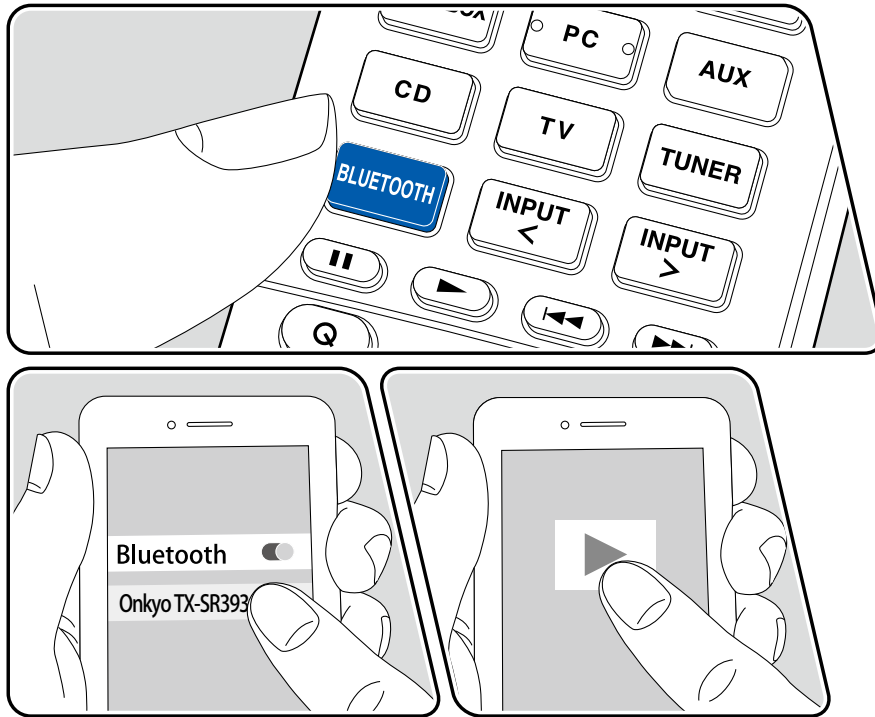

Perform the following procedure when this unit is on.

### Pairing

1. When you press the BLUETOOTH button, "Now Pairing..." is displayed on this unit's display, and the pairing mode is enabled.

Now Pairing...

2. Enable (turn on) the BLUETOOTH function of the BLUETOOTH-enabled device, and then select this unit from among the devices displayed. If a password is requested, enter "0000".
  - This unit is displayed as "Onkyo TX-SR393D XXXXXX".
  - To connect another BLUETOOTH-enabled device, press and hold the BLUETOOTH button until "Now Pairing..." is displayed, and then perform step 2. This unit can store the pairing information of up to 8 paired devices.
  - The coverage area is approx. 48'/15 m. Note that connection is not always guaranteed with all BLUETOOTH-enabled devices.

### Playing Back

1. Perform the connection procedure on the BLUETOOTH-enabled device.
2. Playing the music file.
 

The input on this unit automatically switches to "BLUETOOTH". Turn up the volume of the BLUETOOTH-enabled device to an appropriate level.

  - Due to the characteristics of BLUETOOTH wireless technology, the sound produced on this unit may slightly be behind the sound played on the BLUETOOTH-enabled device.

## Listening To the FM Radio

You can receive FM radio stations on this unit with the built-in tuner.

### Tuning into a Radio Station

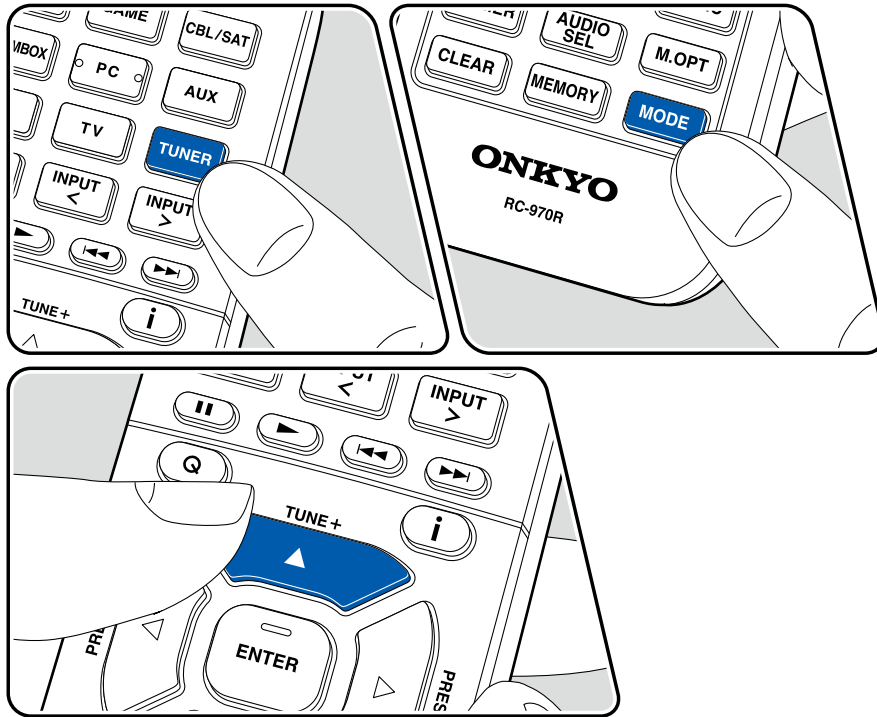

Perform the following procedure when this unit is on.

### Tuning Automatically

1. Press TUNER repeatedly to select "FM".
2. Press MODE repeatedly to display "TunMode: Auto"

TunMode: Auto

3. When you press the cursors ▲ / ▼, automatic tuning starts, and searching stops when a station is found. When tuned in to a radio station, the "TUNED" indicator on the display lights up. When tuned in to an FM radio station, the "FM ST" indicator lights up.

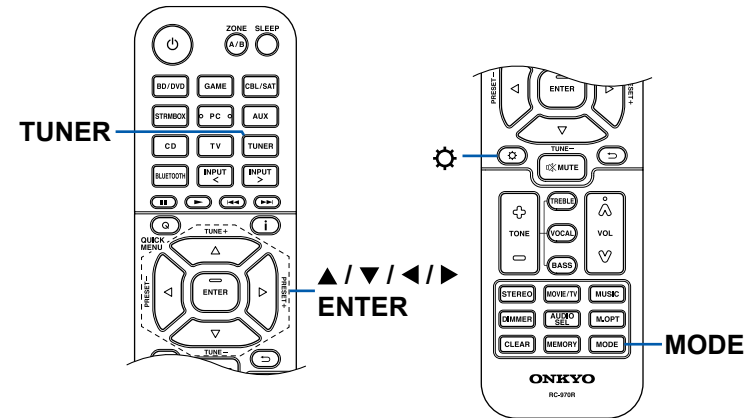

**When FM broadcasts reception is poor:** Perform the procedure for "Tuning Manually" ( →[p38](#)). Note that if you tune manually, the reception for FM broadcasts will be monaural rather than stereo, irrespective of the sensitivity of the reception.

## Tuning Manually

Note that if you tune manually, the reception for FM broadcasts will be monaural rather than stereo, irrespective of the sensitivity of the reception.

1. Press TUNER repeatedly to select "FM".
2. Press MODE repeatedly to display "TunMode: Manual" on the display.

*TunMode:Manual*

3. While pressing the cursors ▲ / ▼, select the desired radio station.
  - Each time you press the cursors ▲ / ▼, the frequency changes by 1 step. If the button is held down, the frequency changes continuously, and if the button is released, the frequency stops changing.

## ❑ Presetting a Radio Station ( →[p39](#))

## Presetting a Radio Station

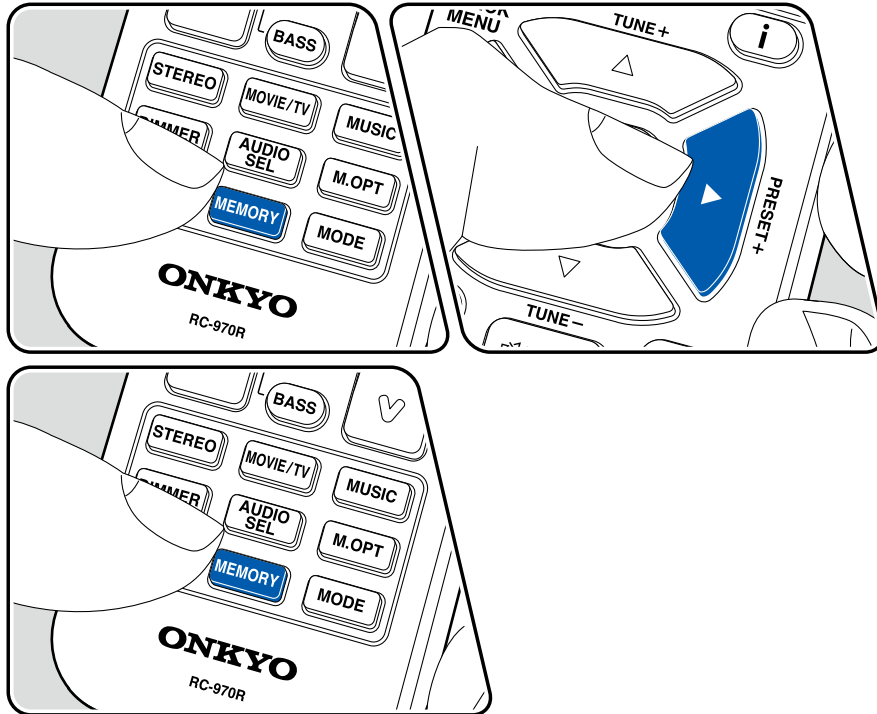

### Registration Procedure

You can preset up to 40 of your favorite radio stations.

After tuning in to the radio station you want to register, perform the following procedure.

1. Press MEMORY so that the preset number on the display blinks.

FM 87.5 MHz |

2. While the preset number is blinking (approx. 8 seconds), repeatedly press the cursors ◀/▶ to select a number between 1 and 40.
3. Press MEMORY again to register the station.

When the station is registered, the preset number stops blinking. Repeat this steps to register your favorite radio stations.

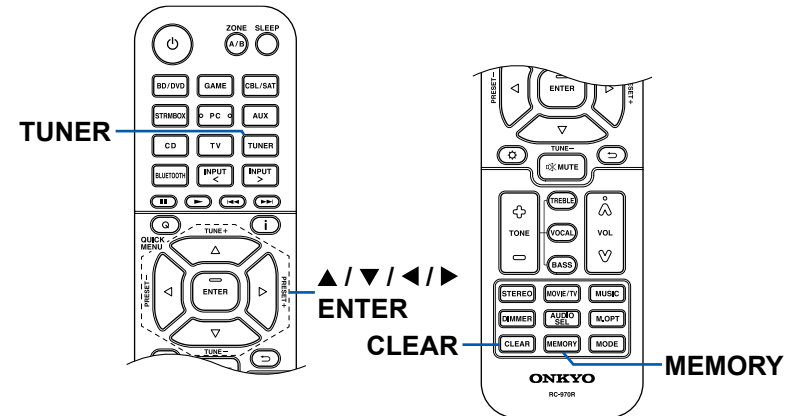

## Selecting a Preset Radio Station

1. Press TUNER.
2. Press the cursors ◀/▶ to select a preset number.

## Deleting a Preset Radio Station

1. Press TUNER.
2. Press the cursors ◀/▶ to select the preset number to delete.
3. After pressing MEMORY, press CLEAR while the preset number is blinking, and delete the preset number. When deleted, the number on the display disappears.

□ Using RDS ( →[p41](#))



## Using RDS

RDS stands for Radio Data System, and is a method of transmitting data in FM radio signals. In regions where RDS can be used, when you tune in to a radio station broadcasting program information, the radio station name is displayed on the display. When you press **i** on the remote controller in this state, you can use the following functions.

### Display Text Information (Radio Text)

1. While the name of the station is being displayed on the display, press **i** on the remote controller once.  
The Radio Text (RT), which is text information delivered by the station, is displayed scrolling across the display. "No Text Data" is displayed when no text information is delivered.

### Search for Stations by Program Type

1. While the name of the station is being displayed on the display, press **i** on the remote controller twice.
  - If none of the Program Types are set for the radio station under reception, "None" is displayed.
2. Press the cursors **◀/▶** on the remote controller to select the Program Type you want to search for, and then press the ENTER button to start the search.
  - The Program Types displayed are as follows: None / News (News reports) / Affairs (Current affairs) / Info (Information) / Sport / Educate (Education) / Drama / Culture / Science (Science and technology) / Varied / Pop M (Pop music) / Rock M (Rock music) / Easy M (Middle of the road music) / Light M (Light classics) / Classics (Serious classics) / Other M (Other music) / Weather / Finance / Children (Children's programmes) / Social (Social affairs) / Religion / Phone In / Travel / Leisure / Jazz (Jazz music) / Country (Country music) / Nation M (National music) / Oldies (Oldies music) / Folk M (Folk music) / Document (Documentary)
  - The information displayed may not match the content delivered by the station.
3. When a station is found, the station blinks on the display. Pressing the ENTER button in this state will receive that station. If you don't press the ENTER button, the unit starts to search for another station.

- If no stations are found, the message "Not Found" is displayed.
- Unusual characters may be displayed when the unit receives unsupported characters. This is not a malfunction. Also, if the signal from a station is weak, information may not be displayed.

## Listening To the DAB Digital Radio

### Basic Operations

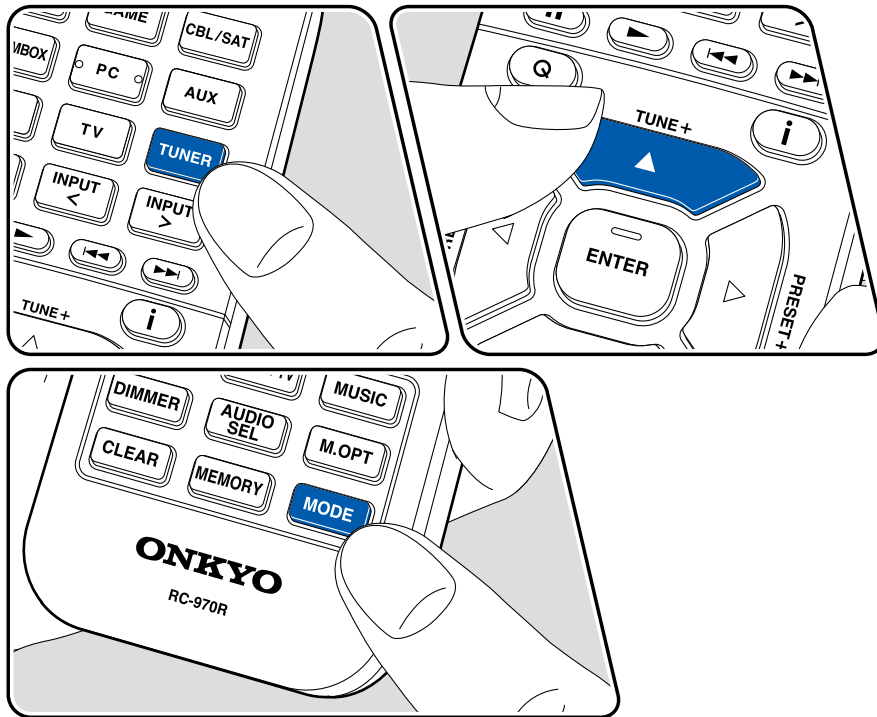

Perform the following procedure when this unit is on.

1. Press TUNER repeatedly to select "DAB".
  - The very first time you select DAB, the Auto Tuning function automatically scans the DAB Band 3 for the multiplexes (i.e., stations) available in your area. Once the scanning process is complete, the first station that was detected is selected.

Scan# 100%

2. Select the desired radio station with ▲ / ▼ on the remote controller.
  - If a new DAB station is introduced, or you move to a new area, press ⚙ on the remote controller, then use the cursors and ENTER button to run the "DAB Auto Scan" in "6. Miscellaneous" - "Tuner".

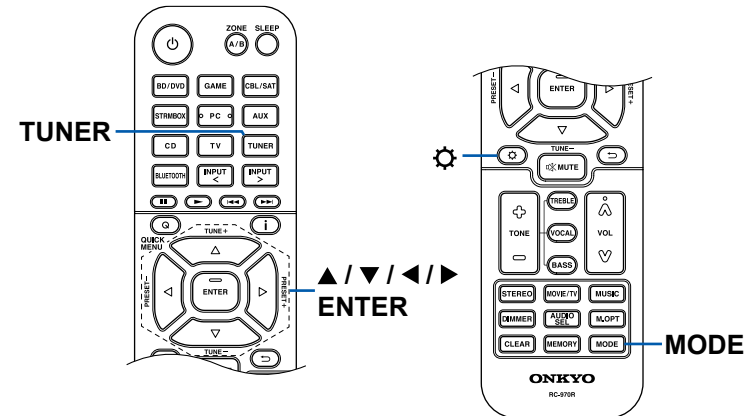

## Changing the order stations are displayed

You can sort the available stations alphabetically or by multiplex.

1. Press TUNER repeatedly to select "DAB".
2. Press MODE repeatedly to set the method for sorting the display order from the following.

**Alphabet (default setting):** Sort stations alphabetically.

**Multiplex:** Sort stations by multiplex.

## Displaying DAB Radio Information

1. Press the **i** repeatedly to display more information about the selected DAB station.

**DLS (Dynamic Label Segment):** When tuned to a station that's broadcasting DLS text data, the text will scroll across the display.

**Program Type:** Displays the type of program.

**Bit Rate and Audio Mode:** Displays the station's bit rate and audio mode (Stereo, Mono).

**Quality:** Displays the signal quality.

0 - 59: Poor reception

60 - 79: Good reception

80 - 100: Excellent reception

**Multiplex Name:** Displays the name of the current multiplex.

**Multiplex Number and Frequency:** Displays the number and frequency of the current multiplex.

## ZONE B Playback

While performing playback in the main room (ZONE A), you can enjoy the audio of the same source in the separate room (ZONE B) at the same time.

### Playing Back

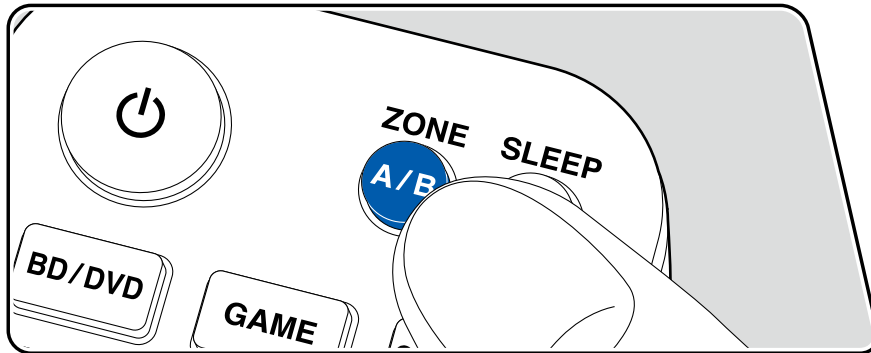

1. Press ZONE A/B to select an audio output destination.
  - ZONE A: Outputs audio only to the main room (ZONE A). "A" on the display of the main unit lights up.
  - ZONE B: Outputs audio only to the separate room (ZONE B). "B" on the display of the main unit lights up.
  - ZONE A+B: Outputs audio to both the main room (ZONE A) and separate room (ZONE B). "A" and "B" on the display of the main unit light up.

AB

2. Start play on the AV component.
3. If the unit is connected to the pre-main amplifier in the separate room, adjust the volume on the pre-main amplifier.

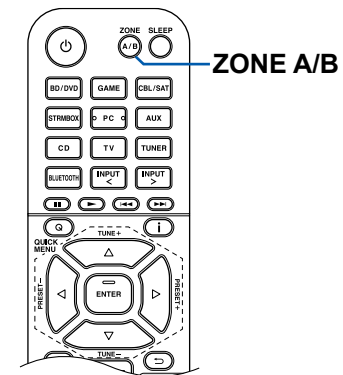

If "ZONE A+B" is selected as an audio output destination, you can select only the "Stereo" listening mode for the main room (ZONE A) when using the 2.1ch speaker layout. When using a speaker layout of 3.1ch or more, you can select only the "AllCh Stereo" listening mode.

## Convenience functions

### Displaying Your Favorite Video on TV While Playing Music

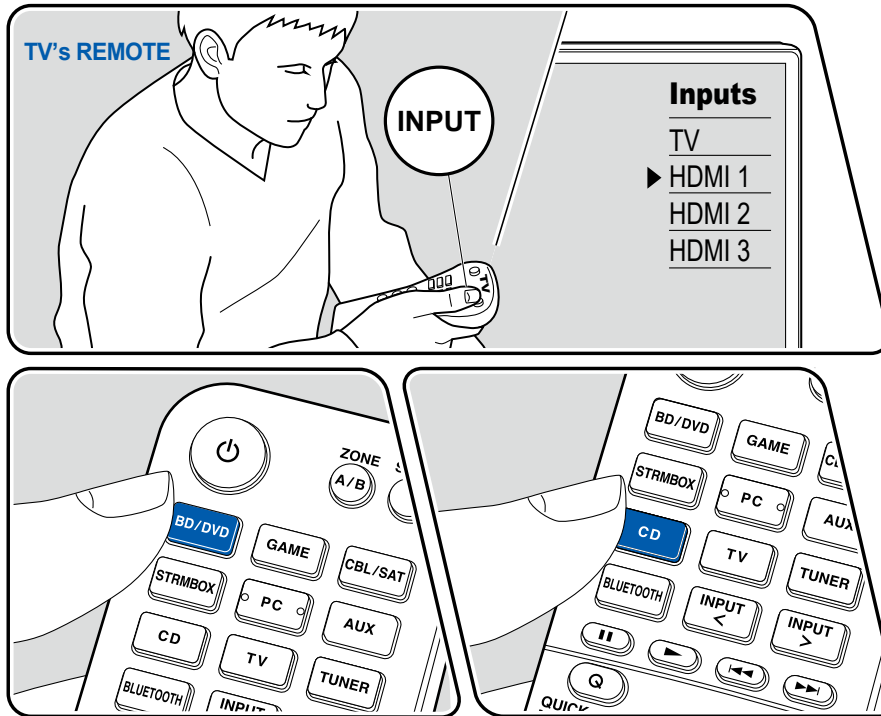

While listening to the music from a CD or BLUETOOTH-enabled device, you can display video on TV from an AV component such as a Blu-ray Disc player.

- For audio playback, you can select an input selector to which video input is not assigned, such as "CD", "TUNER", and "BLUETOOTH".
- When "OSD Language" ( →p68) is set to Chinese, the audio from "BLUETOOTH" cannot be played.

Perform the following procedure when this unit is on.

1. Switch the input on the TV to the input connected to the unit.
2. Press an input selector such as BD/DVD button connected to the AV component of which the video is to be displayed on TV.
  - This operation is not necessary if the same input selector has been selected in the previous operation.
3. Press an input selector of the audio you want to play, such as the CD or BLUETOOTH button and perform playback operation.
4. Perform the playback operation of the AV component such as a Blu-ray Disc player. To play the audio of BLUETOOTH, the following step 5 operation is required.
5. To play the audio of BLUETOOTH, press the MODE button to switch the TV display from the BLOOTOOTH playback screen to the video of the AV component. Pressing the MODE button again will return to the BLOOTOOTH playback screen.
  - When the TV display is switched to the video of the AV component, the playback screen of BLUETOOTH is displayed on the corner of the screen as Mini Player. The setting for Mini Player can be changed on the Setup Menu so that it automatically turns off in 30 seconds after displayed. ( →p68 "Mini Player OSD")

**Setting the video source to be displayed on TV beforehand:** When playing the audio of "TUNER" and "BLUETOOTH", you can set the input selector to be displayed on TV beforehand using "Video Select" ( →p76) on the Setup Menu. If a value other than "Last" is set, step 2 in the operation procedure is not required.

## Adjusting the tone

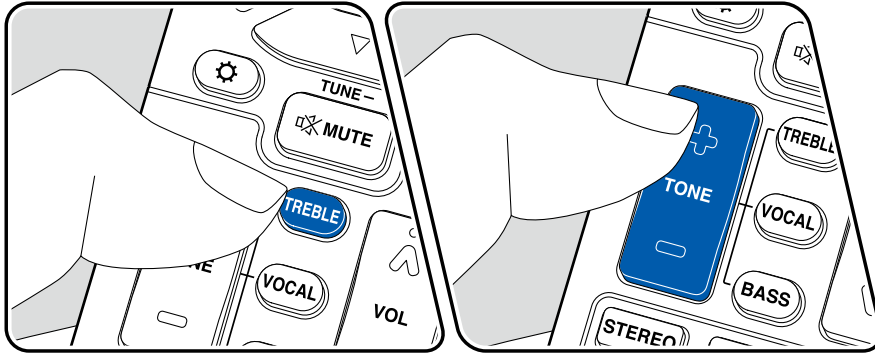

### Adjusting TREBLE/BASS

You can adjust the sound quality of the front speakers.

1. Press TREBLE or BASS to select the setting to adjust.  
 TREBLE: Enhances or moderates the high-tone range of the front speakers.  
 BASS: Enhances or moderates the low-tone range of the front speakers.
2. Press + or - for adjustment.

### Adjusting VOCAL

Emphasizes movie lines and music vocals to listen to them more easily. It is effective to movie lines in particular. Also, it exerts the effect even if the center speaker is not used. Select a desired level from "1" (low) to "5" (high).

1. Press VOCAL.
2. Press + or - for adjustment.
  - Depending on the input source or listening mode setting, selection is not possible, or the desired effect may not be achieved.

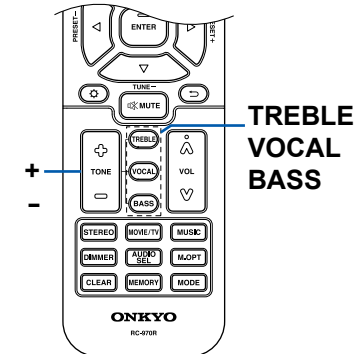

## Sleep Timer

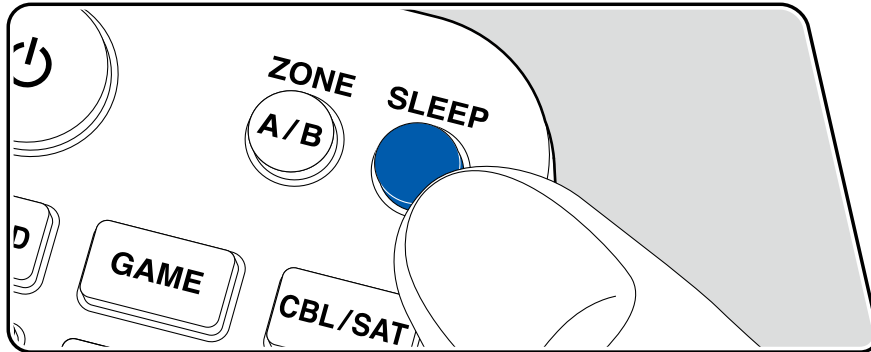

You can allow the unit to enter standby automatically when the specified time has elapsed.

Press SLEEP button on the remote controller to select the time from "30 min", "60 min" and "90 min".

"Off": The unit does not automatically enter standby mode.

You can also set this by pressing the ⚙ button on the remote controller and selecting "5. Hardware" - "Power Management" - "Sleep Timer" ( →[p79](#)) on the Setup menu.



## Listening Mode

This unit is equipped with a variety of listening modes, and you can select the optimum listening mode by pressing STEREO, MOVIE/TV or MUSIC.

### Selecting a Listening mode

1. Press one from among STEREO, MOVIE/TV and MUSIC during playback.
2. Press the selected button repeatedly to switch the modes displayed on the display of the main unit.

DTS

- Each of STEREO, MOVIE/TV and MUSIC buttons stores the listening mode that was selected last. If content incompatible of the listening mode selected last is played, the most standard listening mode for the content is automatically selected.
- For details of the effects of each listening mode, refer to "Listening Mode Effects" (→[p53](#)).
- For listening modes selectable for each audio format of input signals, refer to "Input Formats and Selectable Listening Modes" (→[p57](#)).

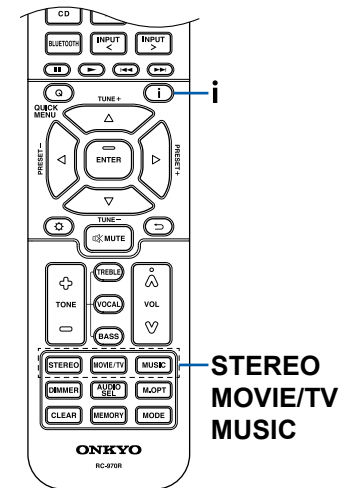

## Checking the input format and listening mode

Pressing **i** button on the remote controller or INFO button on the main unit repeatedly will switch the display of the main unit in the following order.

- When using a BLUETOOTH connection, press the INFO button on the main unit.
- Not all the information is necessarily displayed.

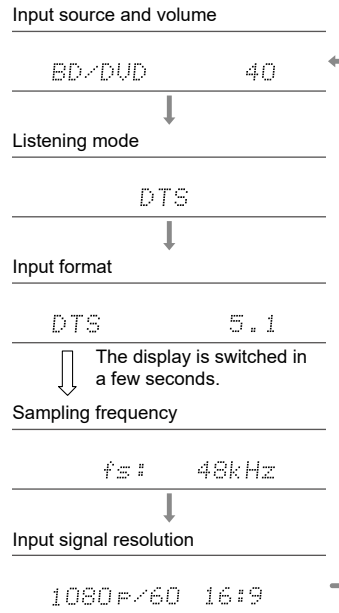

## Speaker Layouts and Selectable Listening Modes

See the following table for selectable listening modes for each speaker layout.

Listening mode	Speaker layout					
	2.1 ch	3.1 ch	4.1 ch	5.1 ch	2.1.2 ch	3.1.2 ch
<input checked="" type="checkbox"/> DD (Dolby Audio - DD)		✓(*1)	✓(*1)	✓(*1)		✓(*2)
<input checked="" type="checkbox"/> DD+ (Dolby Audio - DD+)		✓(*1)	✓(*1)	✓(*1)	✓(*1)	✓(*1)
<input checked="" type="checkbox"/> DTHD (Dolby Audio - TrueHD)		✓(*1)	✓(*1)	✓(*1)	✓(*1)	✓(*1)
<input checked="" type="checkbox"/> Atmos 2.0/2.1	✓					
<input checked="" type="checkbox"/> Atmos 3.0/3.1		✓				
<input checked="" type="checkbox"/> Atmos 4.0/4.1			✓			
<input checked="" type="checkbox"/> Atmos 5.0/5.1				✓		
<input checked="" type="checkbox"/> Atmos 2.0.2/2.1.2					✓	
<input checked="" type="checkbox"/> Atmos 3.0.2/3.1.2						✓
<input checked="" type="checkbox"/> DSur 2.0/2.1 (Dolby Audio - Surr)	✓					
<input checked="" type="checkbox"/> DSur 3.0/3.1 (Dolby Audio - Surr)		✓				
<input checked="" type="checkbox"/> DSur 4.0/4.1 (Dolby Audio - Surr)			✓			
<input checked="" type="checkbox"/> DSur 5.0/5.1 (Dolby Audio - Surr)				✓		
<input checked="" type="checkbox"/> DSur 2.0.2/2.1.2 (Dolby Audio - Surr)					✓	
<input checked="" type="checkbox"/> DSur 3.0.2/3.1.2 (Dolby Audio - Surr)						✓

Listening mode	Speaker layout					
	2.1 ch	3.1 ch	4.1 ch	5.1 ch	2.1.2 ch	3.1.2 ch
DTS		✓	✓	✓		✓(*2)
DTS 96/24		✓	✓	✓		✓(*2)
DTS-HD HR (DTS-HD High Resolution)		✓	✓	✓		✓
DTS-HD Master (DTS-HD Master Audio)		✓	✓	✓		✓
DTS Express		✓	✓	✓		✓
DTS:X		✓	✓	✓	✓	✓
DTS Neural:X	✓	✓	✓	✓	✓	✓
DTS Virtual:X	✓	✓	✓	✓		
Multich (Multichannel)		✓(*1)	✓(*1)	✓(*1)		✓(*2)
DSD		✓(*1)	✓(*1)	✓(*1)		✓(*2)
Direct	✓	✓(*1)	✓(*1)	✓(*1)	✓(*1)	✓(*1)
Stereo	✓	✓(*3)	✓(*3)	✓(*3)	✓(*3)	✓(*3)
Mono	✓	✓(*4)	✓(*3)	✓(*4)	✓(*3)	✓(*4)
Full Mono		✓	✓	✓	✓	✓
AllCh Stereo		✓	✓	✓	✓	✓
Orchestra			✓	✓	✓	✓
Studio-Mix			✓	✓	✓	✓
TV Logic			✓	✓	✓	✓
Unplugged			✓	✓	✓	✓
T-D (Theater-Dimensional)	✓	✓	✓(*3)	✓(*5)	✓(*3)	✓(*5)

\*1: Reproduced with the sound field according to the number of channels of input signals.

\*2: Not output from height speakers.

\*3: Output only from front speakers.

\*4: Output only from center speaker.

\*5: Output only from front speakers and center speaker.

## Listening Mode Effects

### In alphabetical order

#### ■ AllCh Stereo

This mode is ideal for background music. Stereo sound is played through the surround speakers as well as the front speakers, creating a stereo image.

#### ■ Direct







This listening mode can be selected for all input signals. Processing that affects sound quality is shut down, and sound closer to the original is reproduced. The sound is reproduced with the sound field based on the number of channels in the input signal. For example, a 2 ch signal is output only from the front speakers. Note that the sound adjustment is not available when this mode is selected.

#### ■ Atmos

Since this mode calculates the positional data of audio recorded in Dolby Atmos audio in real-time and outputs it from appropriate speakers, you can enjoy the natural and stereophonic sound field of Dolby Atmos with any speaker layout including connection of only front speakers. Also, the Dolby Atmos sound design can be reproduced more faithfully by connecting height speakers. You can select this mode when inputting the Dolby Atmos audio format.

Unlike existing surround systems, Dolby Atmos does not rely on channels, but rather enables the accurate placement of sound objects that have independent motion in a 3D space with even greater clarity. Dolby Atmos is an optional audio format for Blu-ray Discs and achieves a more stereophonic sound field by introducing a sound field above the listener.

According to the speaker layout, the following listening modes are displayed.

-  Atmos 2.0/2.1: When only front speakers are installed
-  Atmos 3.0/3.1: When front speakers and center speaker are installed
-  Atmos 4.0/4.1: When front speakers and surround speakers are installed
-  Atmos 5.0/5.1: When front speakers, center speaker and surround speakers are installed
-  Atmos 2.0/2.1.2: When front speakers and height speakers are installed
-  Atmos 3.0/2/3.1.2: When front speakers, center speaker and height speakers are installed

- To enable transfer of this audio format, connect via an HDMI cable and set the audio output on the player to Bitstream output.
- When "Speaker Virtualizer" (→p73) is set to "Off" (Default: On), modes other than  Atmos cannot be selected.

#### ■ DD (Dolby Audio - DD)

This mode faithfully reproduces the sound design recorded in the Dolby Digital audio format.

Dolby Digital is a multi-channel digital format developed by Dolby Laboratories, Inc. and is widely adopted for use in movie production. It is also a standard audio format for DVD-Video and Blu-ray Discs. It is possible to record a maximum of 5.1 channels on a DVD-Video or Blu-ray Disc; two front channels, one center channel, two surround channels, and the LFE channel dedicated to the bass region (sound elements for the subwoofer).

- To enable transfer of this audio format, connect via a digital cable and set audio output on the player to Bitstream output.

#### ■ DD+ (Dolby Audio - DD+)

This mode faithfully reproduces the sound design recorded in the Dolby Digital Plus audio format.

The Dolby Digital Plus format has been improved based on Dolby Digital, increasing the number of channels and endeavoring to improve sound quality by giving more flexibility in data bit rates. Dolby Digital Plus is an optional audio format based on 5.1 ch for Blu-ray Discs. It is possible to record a maximum of 7.1 channels with additional channels such as the surround back channel.







- To enable transfer of this audio format, connect via an HDMI cable and set audio output on the player to Bitstream output.

#### ■ DSurr (Dolby Audio - Surr)

This listening mode expands 2 ch input signals to 5.1 ch. This mode expands actual channels to more channels for playback according to the configuration of the connected speakers. Also, even if there is no speaker for expansion, for example when only front speakers are connected, audio of surround channel or height channel is virtually created for expansion playback.

- This mode cannot be selected when DTS signal is input.

According to the speaker layout, the following listening modes are displayed.

-  **DSur 2.0/2.1**: When only front speakers are installed
-  **DSur 3.0/3.1**: When front speakers and center speaker are installed
-  **DSur 4.0/4.1**: When front speakers and surround speakers are installed
-  **DSur 5.0/5.1**: When front speakers, center speaker and surround speakers are installed
-  **DSur 2.0.2/2.1.2**: When front speakers and height speakers are installed
-  **DSur 3.0.2/3.1.2**: When front speakers, center speaker and height speakers are installed
- When "Speaker Virtualizer" (→p73) is set to "Off" (Default: On), modes other than  DSur cannot be selected.

## **DTHD (Dolby Audio - TrueHD)**

This mode faithfully reproduces the sound design recorded in the Dolby TrueHD audio format.

The Dolby TrueHD audio format is a "lossless" format expanded based on the lossless compression technology referred to as MLP, and it faithfully reproduces the master audio recorded in the studio. Dolby TrueHD is an optional audio format based on 5.1 ch for Blu-ray Discs. It is possible to record a maximum of 7.1 channels with additional channels such as the surround back channel. 7.1 ch is recorded at 96 kHz/24 bit, and 5.1 ch is recorded at 192 kHz/24 bit.

- To enable transfer of this audio format, connect via an HDMI cable and set audio output on the player to Bitstream output.

## **DSD**

This mode is suitable for playing sources recorded in DSD.

- This unit supports the DSD signal input from the HDMI input terminal. However, depending on the connected player, better sound may be obtained by setting the output on the player side to the PCM output.
- This listening mode cannot be selected if the output setting on your Blu-ray Disc/DVD player is not set to DSD.

## **DTS**

This mode faithfully reproduces the sound design recorded in the DTS audio format.

The DTS audio format is a multi-channel digital format developed by DTS, Inc. This format is an optional audio format for DVD-Video and a standard format for Blu-ray Discs. It enables recording of 5.1 channels; two front channels, one center channel, two surround channels, and the LFE channel dedicated to the bass region (sound elements for the subwoofer). The content is recorded with a rich volume of data, with a maximum sampling rate of 48 kHz, at a resolution of 24 bits and a bit rate of 1.5 Mbps.

- To enable transfer of this audio format, connect via a digital cable and set audio output on the player to Bitstream output.

## **DTS 96/24**

This mode faithfully reproduces the sound design recorded in the DTS 96/24 audio format.

The DTS 96/24 format is an optional audio format for DVD-Video and Blu-ray Discs. It enables recording of 5.1 channels; two front channels, one center channel, two surround channels, and the LFE channel dedicated to the bass region (sound elements for the subwoofer). Detailed reproduction is achieved by recording the content at a sampling rate of 96 kHz and at a resolution of 24 bits.

- To enable transfer of this audio format, connect via a digital cable and set audio output on the player to Bitstream output.

## **DTS Express**

This mode faithfully reproduces the sound design recorded in the DTS Express audio format.

DTS Express is an optional audio format based on 5.1 ch for Blu-ray Discs. It is possible to record a maximum of 7.1 channels with additional channels such as the surround back channel. It also supports low bit rates.

- To enable transfer of this audio format, connect via an HDMI cable and set audio output on the player to Bitstream output.

## **DTS-HD HR (DTS-HD High Resolution)**

This mode faithfully reproduces the sound design recorded in the DTS-HD High Resolution Audio audio format.

DTS-HD High Resolution Audio is an optional audio format based on 5.1 ch for Blu-ray Discs. It is possible to record a maximum of 7.1 channels with additional channels such as the surround back channel at a sampling rate of 96 kHz and at a resolution of 24 bits.

- To enable transfer of this audio format, connect via an HDMI cable and set audio output on the player to Bitstream output.

## ■ DTS-HD MSTR (DTS-HD Master Audio)

This mode faithfully reproduces the sound design recorded in the DTS-HD Master Audio audio format.

DTS-HD Master Audio is an optional audio format based on 5.1 ch for Blu-ray Discs. It is possible to record a maximum of 7.1 channels with additional channels such as the surround back channel using the lossless audio reproduction technology. 96 kHz/24 bit is supported for 7.1 ch, and 192 kHz/24 bit is supported for 5.1 ch.

- To enable transfer of this audio format, connect via an HDMI cable and set audio output on the player to Bitstream output.

## ■ DTS Neural:X

This listening mode expands actual channels to more channels for playback to suit the configuration of the connected speakers by expanding the input signals from 2 channels to 5.1 channels.

- This mode cannot be selected when Dolby signal is input.

## ■ DTS Virtual:X

DTS Virtual:X listening mode uses the proprietary audio processing technology to create spacious 3D sound including audio from up above without connecting height speakers.

This mode can be selected in any speaker layout such as front speakers-only connection. You can enjoy your favorite movies or TV programs with a more immersive audio experience.

- This mode cannot be selected when Dolby signal is input or height speakers are connected.
- This mode cannot be selected when "Speaker Virtualizer" (→[p73](#)) is set to "Off" (Default: On).

## ■ DTS:X

This mode faithfully reproduces the sound design recorded in the DTS:X audio format.

The DTS:X audio format is a combination of the mixing method based on

traditional channel based formats (5.1 ch and 7.1 ch) and object based dynamic audio mixing, and it is characterized by the precise positioning of sounds and the ability to express sound movement.

- To enable transfer of this audio format, connect via an HDMI cable and set audio output on the player to Bitstream output.

## ■ Full Mono

In this mode, all speakers output the same sound in mono, so the sound you hear is the same regardless of where you are within the listening room.

## ■ Mono

In this mode, monaural audio is played from the center speaker at the time of inputting an analog signal or PCM signal. If there is no center speaker connected, monaural audio is played from the front speakers.

## ■ Multich (Multichannel)

This mode is suitable to play sources recorded in multichannel PCM.

## ■ Orchestra

This mode is suitable for classical or operatic music. This mode emphasizes the surround channels in order to widen the sound image, and simulates the natural reverberation of a large hall.

## ■ Stereo

In this mode, sound is output from the right and left front speakers and subwoofer.

## ■ Studio-Mix

This mode is suitable for rock or pop music. This mode creates a lively sound field with a powerful acoustic image as if you are at a club or rock concert.

## ■ T-D (Theater-Dimensional)

In this mode, you can enjoy a virtual playback of multichannel surround sound even with only two or three speakers. This works by controlling how sounds reach the listener's left and right ears.

- This mode cannot be selected when "Speaker Virtualizer" (→[p73](#)) is set to

"Off" (Default: On).

## ■ TV Logic

Suitable for TV shows produced in a TV studio. This mode gives clarity to voices by enhancing the entire surround sounds, and creates a realistic acoustic image.

## ■ Unplugged

Suitable for acoustic instruments, vocals and jazz. This mode emphasizes the front sound field image, giving the impression of being in front of the stage.



## Input Formats and Selectable Listening Modes

You can select a variety of listening modes according to the audio format of the signal to be input.

- Selectable listening modes with the STEREO button are Stereo and AllCh Stereo only.
- List of listening modes selectable with the MOVIE/TV button ( →[p57](#))
- List of listening modes selectable with the MUSIC button ( →[p60](#))
- Selectable listening modes when headphones are connected are Mono, Direct, and Stereo only.

### MOVIE/TV button

Input Format	Listening Mode
Analog	Direct
	Mono
	<input checked="" type="checkbox"/> DSur
	DTS Neural:X
	DTS Virtual:X <sup>1</sup> <sup>2</sup>
	TV Logic <sup>3</sup>
	AllCh Stereo <sup>4</sup>
	Full Mono <sup>4</sup>
T-D <sup>1</sup>	

<sup>1</sup> Cannot be selected if "Speaker Virtualizer" is set to "Off".

<sup>2</sup> Cannot be selected when height speakers are installed.

<sup>3</sup> Surround speakers or height speakers need to be installed.

<sup>4</sup> A center speaker, surround speakers, or height speakers need to be installed.

Input Format	Listening Mode
PCM	Direct
	Mono
	<input checked="" type="checkbox"/> DSur
	DTS Neural:X <sup>1</sup>
	DTS Virtual:X <sup>2</sup> <sup>3</sup>
	TV Logic <sup>4</sup>
	AllCh Stereo <sup>5</sup>
	Full Mono <sup>5</sup>
T-D <sup>2</sup>	

<sup>1</sup> Cannot be selected when the input format is monaural.

<sup>2</sup> Cannot be selected if "Speaker Virtualizer" is set to "Off".

<sup>3</sup> Cannot be selected when height speakers are installed.

<sup>4</sup> Surround speakers or height speakers need to be installed.

<sup>5</sup> A center speaker, surround speakers, or height speakers need to be installed.

### Speaker Layouts and Selectable Listening Modes ( →[p51](#))

Input Format	Listening Mode
Multich PCM	Direct
	Multich <sup>1</sup>
	<input checked="" type="checkbox"/> DSur
	DTS Neural:X
	DTS Virtual:X <sup>2 3</sup>
	TV Logic <sup>4</sup>
	AllCh Stereo <sup>5</sup>
	Full Mono <sup>5</sup>
	T-D <sup>2</sup>

<sup>1</sup> A center speaker or surround speakers need to be installed.

<sup>2</sup> Cannot be selected if "Speaker Virtualizer" is set to "Off".

<sup>3</sup> Cannot be selected when height speakers are installed.

<sup>4</sup> Surround speakers or height speakers need to be installed.

<sup>5</sup> A center speaker, surround speakers, or height speakers need to be installed.

Input Format	Listening Mode
DSD	Direct
	DSD <sup>1 2</sup>
	<input checked="" type="checkbox"/> DSur
	DTS Neural:X
	DTS Virtual:X <sup>3 4</sup>
	TV Logic <sup>5</sup>
	AllCh Stereo <sup>6</sup>
	Full Mono <sup>6</sup>
T-D <sup>3</sup>	

<sup>1</sup> Cannot be selected when the input format is monaural or 2 ch.

<sup>2</sup> A center speaker or surround speakers need to be installed.

<sup>3</sup> Cannot be selected if "Speaker Virtualizer" is set to "Off".

<sup>4</sup> Cannot be selected when height speakers are installed.

<sup>5</sup> Surround speakers or height speakers need to be installed.

<sup>6</sup> A center speaker, surround speakers, or height speakers need to be installed.

Input Format	Listening Mode
<input checked="" type="checkbox"/> Atmos	Direct
	<input checked="" type="checkbox"/> Atmos
	TV Logic
	AllCh Stereo
	Full Mono
	T-D <sup>1</sup>

<sup>1</sup> Cannot be selected if "Speaker Virtualizer" is set to "Off".

Input Format	Listening Mode
<input checked="" type="checkbox"/> DD	Direct
	<input checked="" type="checkbox"/> DD <sup>1 2</sup>
	<input checked="" type="checkbox"/> DSur
	TV Logic <sup>3</sup>
	AllCh Stereo <sup>4</sup>
	Full Mono <sup>4</sup>
	T-D <sup>5</sup>

<sup>1</sup> Cannot be selected when the input format is 2 ch.

<sup>2</sup> A center speaker or surround speakers need to be installed.

<sup>3</sup> Surround speakers or height speakers need to be installed.

<sup>4</sup> A center speaker, surround speakers, or height speakers need to be installed.

<sup>5</sup> Cannot be selected if "Speaker Virtualizer" is set to "Off".

Input Format	Listening Mode
<input checked="" type="checkbox"/> DD+	Direct
	<input checked="" type="checkbox"/> DD+ <sup>1 2 3</sup>
	<input checked="" type="checkbox"/> DSur
	TV Logic <sup>4</sup>
	AllCh Stereo <sup>5</sup>
	Full Mono <sup>5</sup>
	T-D <sup>6</sup>

<sup>1</sup> Cannot be selected when the input format is 2 ch.

<sup>2</sup> A center speaker or surround speakers need to be installed.

<sup>3</sup>  DD+ cannot be selected if the input source is Blu-ray Disc. You can select the  DD listening mode instead.

<sup>4</sup> Surround speakers or height speakers need to be installed.

<sup>5</sup> A center speaker, surround speakers, or height speakers need to be installed.

<sup>6</sup> Cannot be selected if "Speaker Virtualizer" is set to "Off".

Input Format	Listening Mode
<input checked="" type="checkbox"/> DTHD	Direct
	<input checked="" type="checkbox"/> DTHD <sup>1 2</sup>
	<input checked="" type="checkbox"/> DSur
	TV Logic <sup>3</sup>
	AllCh Stereo <sup>4</sup>
	Full Mono <sup>4</sup>
	T-D <sup>5</sup>

<sup>1</sup> Cannot be selected when the input format is 2 ch.

<sup>2</sup> A center speaker or surround speakers need to be installed.

<sup>3</sup> Surround speakers or height speakers need to be installed.

<sup>4</sup> A center speaker, surround speakers, or height speakers need to be installed.

<sup>5</sup> Cannot be selected if "Speaker Virtualizer" is set to "Off".

## Speaker Layouts and Selectable Listening Modes ( →p51)

Input Format	Listening Mode
DTS	Direct
	DTS <sup>1 2</sup>
	DTS Neural:X <sup>3</sup>
	DTS Virtual:X <sup>4 5</sup>
	TV Logic <sup>6</sup>
	AllCh Stereo <sup>7</sup>
	Full Mono <sup>7</sup>
	T-D <sup>4</sup>

- <sup>1</sup> Cannot be selected when the input format is 2 ch.
- <sup>2</sup> A center speaker or surround speakers need to be installed.
- <sup>3</sup> Cannot be selected when the input format is monaural.
- <sup>4</sup> Cannot be selected if "Speaker Virtualizer" is set to "Off".
- <sup>5</sup> Cannot be selected when height speakers are installed.
- <sup>6</sup> Surround speakers or height speakers need to be installed.
- <sup>7</sup> A center speaker, surround speakers, or height speakers need to be installed.

Input Format	Listening Mode
DTS 96/24	Direct
	DTS 96/24 <sup>1 2</sup>
	DTS Neural:X <sup>3</sup>
	DTS Virtual:X <sup>4 5</sup>
	TV Logic <sup>6</sup>
	AllCh Stereo <sup>7</sup>
	Full Mono <sup>7</sup>
	T-D <sup>4</sup>

- <sup>1</sup> Cannot be selected when the input format is 2 ch.
- <sup>2</sup> A center speaker or surround speakers need to be installed.
- <sup>3</sup> Cannot be selected when the input format is monaural.
- <sup>4</sup> Cannot be selected if "Speaker Virtualizer" is set to "Off".
- <sup>5</sup> Cannot be selected when height speakers are installed.
- <sup>6</sup> Surround speakers or height speakers need to be installed.
- <sup>7</sup> A center speaker, surround speakers, or height speakers need to be installed.

Input Format	Listening Mode
DTS Express	Direct
	DTS Express <sup>1 2</sup>
	DTS Neural:X <sup>3</sup>
	DTS Virtual:X <sup>4 5</sup>
	TV Logic <sup>6</sup>
	AllCh Stereo <sup>7</sup>
	Full Mono <sup>7</sup>
	T-D <sup>4</sup>

- <sup>1</sup> Cannot be selected when the input format is 2 ch.
- <sup>2</sup> A center speaker or surround speakers need to be installed.
- <sup>3</sup> Cannot be selected when the input format is monaural.
- <sup>4</sup> Cannot be selected if "Speaker Virtualizer" is set to "Off".
- <sup>5</sup> Cannot be selected when height speakers are installed.
- <sup>6</sup> Surround speakers or height speakers need to be installed.
- <sup>7</sup> A center speaker, surround speakers, or height speakers need to be installed.

Input Format	Listening Mode
DTS-HD HR	Direct
	DTS-HD HR <sup>1 2</sup>
	DTS Neural:X <sup>3</sup>
	DTS Virtual:X <sup>4 5</sup>
	TV Logic <sup>6</sup>
	AllCh Stereo <sup>7</sup>
	Full Mono <sup>7</sup>
	T-D <sup>4</sup>

- <sup>1</sup> Cannot be selected when the input format is 2 ch.
- <sup>2</sup> A center speaker or surround speakers need to be installed.
- <sup>3</sup> Cannot be selected when the input format is monaural.
- <sup>4</sup> Cannot be selected if "Speaker Virtualizer" is set to "Off".
- <sup>5</sup> Cannot be selected when height speakers are installed.
- <sup>6</sup> Surround speakers or height speakers need to be installed.
- <sup>7</sup> A center speaker, surround speakers, or height speakers need to be installed.

Input Format	Listening Mode
DTS-HD MSTR	Direct
	DTS-HD MSTR <sup>1 2</sup>
	DTS Neural:X <sup>3</sup>
	DTS Virtual:X <sup>4 5</sup>
	TV Logic <sup>6</sup>
	AllCh Stereo <sup>7</sup>
	Full Mono <sup>7</sup>
	T-D <sup>4</sup>

- <sup>1</sup> Cannot be selected when the input format is 2 ch.
- <sup>2</sup> A center speaker or surround speakers need to be installed.
- <sup>3</sup> Cannot be selected when the input format is monaural.
- <sup>4</sup> Cannot be selected if "Speaker Virtualizer" is set to "Off".
- <sup>5</sup> Cannot be selected when height speakers are installed.
- <sup>6</sup> Surround speakers or height speakers need to be installed.
- <sup>7</sup> A center speaker, surround speakers, or height speakers need to be installed.

Input Format	Listening Mode
DTS-ES	Direct
	DTS
	DTS Neural:X
	DTS Virtual:X <sup>1 2</sup>
	TV Logic <sup>3</sup>
	AllCh Stereo <sup>4</sup>
	Full Mono <sup>4</sup>
	T-D <sup>1</sup>

- <sup>1</sup> Cannot be selected if "Speaker Virtualizer" is set to "Off".
- <sup>2</sup> Cannot be selected when height speakers are installed.
- <sup>3</sup> Surround speakers or height speakers need to be installed.
- <sup>4</sup> A center speaker, surround speakers, or height speakers need to be installed.

## ❑ Speaker Layouts and Selectable Listening Modes ( →p51)

Input Format	Listening Mode
DTS:X	Direct
	DTS:X
	DTS Virtual:X <sup>1 2</sup>
	TV Logic <sup>3</sup>
	AllCh Stereo <sup>4</sup>
	Full Mono <sup>4</sup>
	T-D <sup>1</sup>

<sup>1</sup> Cannot be selected if "Speaker Virtualizer" is set to "Off".

<sup>2</sup> Cannot be selected when height speakers are installed.

<sup>3</sup> Surround speakers or height speakers need to be installed.

<sup>4</sup> A center speaker, surround speakers, or height speakers need to be installed.

## MUSIC button

Input Format	Listening Mode
Analog	Direct
	Stereo
	 DSur
	DTS Neural:X
	DTS Virtual:X <sup>1 2</sup>
	Orchestra <sup>3</sup>
	Unplugged <sup>3</sup>
	Studio-Mix <sup>3</sup>
	AllCh Stereo <sup>4</sup>
	Full Mono <sup>4</sup>

<sup>1</sup> Cannot be selected if "Speaker Virtualizer" is set to "Off".

<sup>2</sup> Cannot be selected when height speakers are installed.

<sup>3</sup> Surround speakers or height speakers need to be installed.

<sup>4</sup> A center speaker, surround speakers, or height speakers need to be installed.

Input Format	Listening Mode
PCM	Direct
	Stereo
	 DSur
	DTS Neural:X <sup>1</sup>
	DTS Virtual:X <sup>2 3</sup>
	Orchestra <sup>4</sup>
	Unplugged <sup>4</sup>
	Studio-Mix <sup>4</sup>
	AllCh Stereo <sup>5</sup>
	Full Mono <sup>5</sup>

<sup>1</sup> Cannot be selected when the input format is monaural.

<sup>2</sup> Cannot be selected if "Speaker Virtualizer" is set to "Off".

<sup>3</sup> Cannot be selected when height speakers are installed.

<sup>4</sup> Surround speakers or height speakers need to be installed.

<sup>5</sup> A center speaker, surround speakers, or height speakers need to be installed.

Input Format	Listening Mode
Multich PCM	Direct
	Stereo
	Multich <sup>1</sup>
	 DSur
	DTS Neural:X
	DTS Virtual:X <sup>2 3</sup>
	Orchestra <sup>4</sup>
	Unplugged <sup>4</sup>
	Studio-Mix <sup>4</sup>
	AllCh Stereo <sup>5</sup>
Full Mono <sup>5</sup>	

<sup>1</sup> A center speaker or surround speakers need to be installed.

<sup>2</sup> Cannot be selected if "Speaker Virtualizer" is set to "Off".

<sup>3</sup> Cannot be selected when height speakers are installed.

<sup>4</sup> Surround speakers or height speakers need to be installed.

<sup>5</sup> A center speaker, surround speakers, or height speakers need to be installed.

## Speaker Layouts and Selectable Listening Modes ( →p51)

Input Format	Listening Mode
DSD	Direct
	Stereo
	DSD <sup>*1 *2</sup>
	<input checked="" type="checkbox"/> DSur
	DTS Neural:X
	DTS Virtual:X <sup>*3 *4</sup>
	Orchestra <sup>*5</sup>
	Unplugged <sup>*5</sup>
	Studio-Mix <sup>*5</sup>
	AllCh Stereo <sup>*6</sup>
	Full Mono <sup>*6</sup>

\*1 Cannot be selected when the input format is monaural or 2 ch.

\*2 A center speaker or surround speakers need to be installed.

\*3 Cannot be selected if "Speaker Virtualizer" is set to "Off".

\*4 Cannot be selected when height speakers are installed.

\*5 Surround speakers or height speakers need to be installed.

\*6 A center speaker, surround speakers, or height speakers need to be installed.

Input Format	Listening Mode
<input checked="" type="checkbox"/> DD	Direct
	Stereo
	<input checked="" type="checkbox"/> DD <sup>*1 *2</sup>
	<input checked="" type="checkbox"/> DSur
	Orchestra <sup>*3</sup>
	Unplugged <sup>*3</sup>
	Studio-Mix <sup>*3</sup>
	AllCh Stereo <sup>*4</sup>
	Full Mono <sup>*4</sup>

\*1 Cannot be selected when the input format is 2 ch.

\*2 A center speaker or surround speakers need to be installed.

\*3 Surround speakers or height speakers need to be installed.

\*4 A center speaker, surround speakers, or height speakers need to be installed.

Input Format	Listening Mode
<input checked="" type="checkbox"/> DTHD	Direct
	Stereo
	<input checked="" type="checkbox"/> DTHD <sup>*1 *2</sup>
	<input checked="" type="checkbox"/> DSur
	Orchestra <sup>*3</sup>
	Unplugged <sup>*3</sup>
	Studio-Mix <sup>*3</sup>
	AllCh Stereo <sup>*4</sup>

\*1 Cannot be selected when the input format is 2 ch.

\*2 A center speaker or surround speakers need to be installed.

\*3 Surround speakers or height speakers need to be installed.

\*4 A center speaker, surround speakers, or height speakers need to be installed.

Input Format	Listening Mode
<input checked="" type="checkbox"/> DD+	Direct
	Stereo
	<input checked="" type="checkbox"/> DD+ <sup>*1 *2 *3</sup>
	<input checked="" type="checkbox"/> DSur
	Orchestra <sup>*4</sup>
	Unplugged <sup>*4</sup>
	Studio-Mix <sup>*4</sup>
	AllCh Stereo <sup>*5</sup>

\*1 Cannot be selected when the input format is 2 ch.

\*2 A center speaker or surround speakers need to be installed.

\*3  DD+ cannot be selected if the input source is Blu-ray Disc. You can select the  DD listening mode instead.

\*4 Surround speakers or height speakers need to be installed.

\*5 A center speaker, surround speakers, or height speakers need to be installed.

Input Format	Listening Mode
<input checked="" type="checkbox"/> Atmos	Direct
	Stereo
	<input checked="" type="checkbox"/> Atmos
	Orchestra
	Unplugged
	Studio-Mix
	AllCh Stereo
	Full Mono

## Speaker Layouts and Selectable Listening Modes ( →p51)

Input Format	Listening Mode
DTS	Direct
	Stereo
	DTS <sup>1 2</sup>
	DTS Neural:X <sup>3</sup>
	DTS Virtual:X <sup>4 5</sup>
	Orchestra <sup>6</sup>
	Unplugged <sup>6</sup>
	Studio-Mix <sup>6</sup>
	AllCh Stereo <sup>7</sup>
	Full Mono <sup>7</sup>

<sup>1</sup> Cannot be selected when the input format is 2 ch.

<sup>2</sup> A center speaker or surround speakers need to be installed.

<sup>3</sup> Cannot be selected when the input format is monaural.

<sup>4</sup> Cannot be selected if "Speaker Virtualizer" is set to "Off".

<sup>5</sup> Cannot be selected when height speakers are installed.

<sup>6</sup> Surround speakers or height speakers need to be installed.

<sup>7</sup> A center speaker, surround speakers, or height speakers need to be installed.

Input Format	Listening Mode
DTS Express	Direct
	Stereo
	DTS Express <sup>1 2</sup>
	DTS Neural:X <sup>3</sup>
	DTS Virtual:X <sup>4 5</sup>
	Orchestra <sup>6</sup>
	Unplugged <sup>6</sup>
	Studio-Mix <sup>6</sup>
	AllCh Stereo <sup>7</sup>
	Full Mono <sup>7</sup>

<sup>1</sup> Cannot be selected when the input format is 2 ch.

<sup>2</sup> A center speaker or surround speakers need to be installed.

<sup>3</sup> Cannot be selected when the input format is monaural.

<sup>4</sup> Cannot be selected if "Speaker Virtualizer" is set to "Off".

<sup>5</sup> Cannot be selected when height speakers are installed.

<sup>6</sup> Surround speakers or height speakers need to be installed.

<sup>7</sup> A center speaker, surround speakers, or height speakers need to be installed.

Input Format	Listening Mode
DTS-HD MSTR	Direct
	Stereo
	DTS-HD MSTR <sup>1 2</sup>
	DTS Neural:X <sup>3</sup>
	DTS Virtual:X <sup>4 5</sup>
	Orchestra <sup>6</sup>
	Unplugged <sup>6</sup>
	Studio-Mix <sup>6</sup>
	AllCh Stereo <sup>7</sup>
	Full Mono <sup>7</sup>

<sup>1</sup> Cannot be selected when the input format is 2 ch.

<sup>2</sup> A center speaker or surround speakers need to be installed.

<sup>3</sup> Cannot be selected when the input format is monaural.

<sup>4</sup> Cannot be selected if "Speaker Virtualizer" is set to "Off".

<sup>5</sup> Cannot be selected when height speakers are installed.

<sup>6</sup> Surround speakers or height speakers need to be installed.

<sup>7</sup> A center speaker, surround speakers, or height speakers need to be installed.

Input Format	Listening Mode
DTS 96/24	Direct
	Stereo
	DTS 96/24 <sup>1 2</sup>
	DTS Neural:X <sup>3</sup>
	DTS Virtual:X <sup>4 5</sup>
	Orchestra <sup>6</sup>
	Unplugged <sup>6</sup>
	Studio-Mix <sup>6</sup>
	AllCh Stereo <sup>7</sup>
	Full Mono <sup>7</sup>

<sup>1</sup> Cannot be selected when the input format is 2 ch.

<sup>2</sup> A center speaker or surround speakers need to be installed.

<sup>3</sup> Cannot be selected when the input format is monaural.

<sup>4</sup> Cannot be selected if "Speaker Virtualizer" is set to "Off".

<sup>5</sup> Cannot be selected when height speakers are installed.

<sup>6</sup> Surround speakers or height speakers need to be installed.

<sup>7</sup> A center speaker, surround speakers, or height speakers need to be installed.

Input Format	Listening Mode
DTS-HD HR	Direct
	Stereo
	DTS-HD HR <sup>1 2</sup>
	DTS Neural:X <sup>3</sup>
	DTS Virtual:X <sup>4 5</sup>
	Orchestra <sup>6</sup>
	Unplugged <sup>6</sup>
	Studio-Mix <sup>6</sup>
	AllCh Stereo <sup>7</sup>
	Full Mono <sup>7</sup>

<sup>1</sup> Cannot be selected when the input format is 2 ch.

<sup>2</sup> A center speaker or surround speakers need to be installed.

<sup>3</sup> Cannot be selected when the input format is monaural.

<sup>4</sup> Cannot be selected if "Speaker Virtualizer" is set to "Off".

<sup>5</sup> Cannot be selected when height speakers are installed.

<sup>6</sup> Surround speakers or height speakers need to be installed.

<sup>7</sup> A center speaker, surround speakers, or height speakers need to be installed.

## Speaker Layouts and Selectable Listening Modes ( →p51)

Input Format	Listening Mode
DTS-ES	Direct
	Stereo
	DTS
	DTS Neural:X
	DTS Virtual:X <sup>1 2</sup>
	Orchestra <sup>3</sup>
	Unplugged <sup>3</sup>
	Studio-Mix <sup>3</sup>
	AllCh Stereo <sup>4</sup>
	Full Mono <sup>4</sup>

<sup>1</sup> Cannot be selected if "Speaker Virtualizer" is set to "Off".

<sup>2</sup> Cannot be selected when height speakers are installed.

<sup>3</sup> Surround speakers or height speakers need to be installed.

<sup>4</sup> A center speaker, surround speakers, or height speakers need to be installed.

Input Format	Listening Mode
DTS:X	Direct
	Stereo
	DTS:X
	DTS Virtual:X <sup>1 2</sup>
	Orchestra <sup>3</sup>
	Unplugged <sup>3</sup>
	Studio-Mix <sup>3</sup>
	AllCh Stereo <sup>4</sup>
	Full Mono <sup>4</sup>

<sup>1</sup> Cannot be selected if "Speaker Virtualizer" is set to "Off".

<sup>2</sup> Cannot be selected when height speakers are installed.

<sup>3</sup> Surround speakers or height speakers need to be installed.

<sup>4</sup> A center speaker, surround speakers, or height speakers need to be installed.

❑ **Speaker Layouts and Selectable Listening Modes**  
( → [p51](#) )

## Switching the HDMI 4K Signal Format Input and Output by this Unit

When the AV Component connected to this unit, such as a TV or player, and the HDMI cable (\*) supports the high-definition 4K signal formats (4K 60p 4:4:4, 4:2:2 and 4K 60p 4:2:0 10bit), switch the setting value from "Standard" (default value) to "Enhanced".

(\*)Premium High Speed HDMI Cable or Premium High Speed HDMI Cable with Ethernet that have the "PREMIUM Certified Cable" label attached to the packaging.



Perform the following procedure when the unit is on.

1. While pressing BD/DVD on the main unit, press  $\odot$  ON/STANDBY to display the current setting on the display. While this is being displayed, while pressing BD/ DVD on the main unit, repeatedly press  $\odot$  ON/STANDBY to switch the setting.

### Standard (Default Value)



Select when the AV component connected to this unit, such as a TV or player, supports the standard 4K signal format (4K 60p 4:2:0 8 bit).

### Enhanced



Select when the AV component connected to this unit, such as a TV or player, and the HDMI cable (\*) supports the high-definition 4K signal formats (4K 60p 4:4:4, 4:2:2 and 4K 60p 4:2:0 10 bit).

- There may be some image disruption depending on the connected component and the HDMI cable. If this occurs, switch to "Standard".

2. To exit the settings, release your finger. After a few seconds, the display goes out and the switching is complete.

### Settings and the corresponding resolutions

			Enhanced	Standard
4K (3840×2160p) 24/25/30 Hz 4K SMPTE(4096×2160p) 24/25/30 Hz	RGB/ YCbCr4:4:4	8 bit	✓	✓
		10/12 bit	✓	
	YCbCr4:2:2	12 bit	✓	✓
4K (3840×2160p) 50/60 Hz 4K SMPTE(4096×2160p) 50/60 Hz	RGB/ YCbCr4:4:4	8 bit	✓	
	YCbCr4:2:2	12 bit	✓	
		8 bit	✓	✓
	YCbCr4:2:0	10/12 bit	✓	



## Setup Menu

### Menu list

You can configure advanced settings to have a more enjoyable experience with this unit. For operation details, refer to "Menu operations". ( →[p67](#))

<b>1. Input/Output Assign</b>	<b>1. TV Out / OSD</b>	Make settings for TV output and On-Screen Displays (OSD) that appear on the TV.	<a href="#">p68</a>
	<b>2. HDMI Input</b>	Change input assignment between the input selectors and HDMI IN jacks.	<a href="#">p69</a>
	<b>3. Digital Audio Input</b>	Change input assignment between the input selectors and DIGITAL IN COAXIAL/OPTICAL jacks.	<a href="#">p70</a>
	<b>4. Analog Audio Input</b>	Change input assignment between the input selectors and AUDIO IN jacks.	<a href="#">p70</a>
<b>2. Speaker</b>	<b>1. Configuration</b>	Change the settings of connection environment of the speakers.	<a href="#">p71</a>
	<b>2. Crossover</b>	Change the settings of crossover frequencies.	<a href="#">p71</a>
	<b>3. Distance</b>	Set the distance from each speaker to the listening position.	<a href="#">p72</a>
	<b>4. Level Calibration</b>	Adjust the volume level of each speaker.	<a href="#">p73</a>
	<b>5. Dolby Enabled Speaker</b>	Change the settings of Dolby Enabled Speakers.	<a href="#">p73</a>
	<b>6. Speaker Virtualizer</b>	The Speaker Virtualizer function can be switched between On and Off.	<a href="#">p73</a>
<b>3. Audio Adjust</b>	<b>1. Multiplex/Mono</b>	Change the settings of multiplex audio playback.	<a href="#">p74</a>
	<b>2. Dolby</b>	Change the setting of when Dolby signals are input.	<a href="#">p74</a>
	<b>3. DTS</b>	Change the setting of when DTS signals are input.	<a href="#">p74</a>
	<b>4. LFE Level</b>	Set the low-frequency effect (LFE) level for Dolby Digital series, DTS series, Multichannel PCM, and DSD signals.	<a href="#">p74</a>
	<b>5. Volume</b>	Change the Volume settings.	<a href="#">p75</a>
<b>4. Source</b>	<b>1. IntelliVolume</b>	Adjust the volume level when there are differences in volume level among multiple devices connected to this unit.	<a href="#">p75</a>
	<b>2. Name Edit</b>	Set an easy name for each input.	<a href="#">p75</a>
	<b>Audio Select</b>	Select the priority for input selection when multiple audio sources are connected to one input selector.	<a href="#">p76</a>
	<b>Video Select</b>	When "TUNER" or "BLUETOOTH" input is selected, you can set the input from which video is displayed on the TV.	<a href="#">p76</a>

---

<b>5. Hardware</b>	<b>1. HDMI</b>	Change the settings for the HDMI functions.	<a href="#">p77</a>
	<b>2. Bluetooth</b>	Change the settings for the Bluetooth function.	<a href="#">p78</a>
	<b>3. Power Management</b>	Change the settings for the power-save function.	<a href="#">p79</a>
<b>6. Miscellaneous</b>	<b>1. Tuner</b>	Change the settings for the tuner.	<a href="#">p80</a>
	<b>2. Firmware Update</b>	Change the settings for Firmware Update.	<a href="#">p80</a>
	<b>3. Initial Setup</b>	Make the initial setup from the setup menu.	<a href="#">p80</a>
	<b>4. Lock</b>	Lock the Setup menu so that the settings cannot be changed.	<a href="#">p80</a>

---

## Menu operations

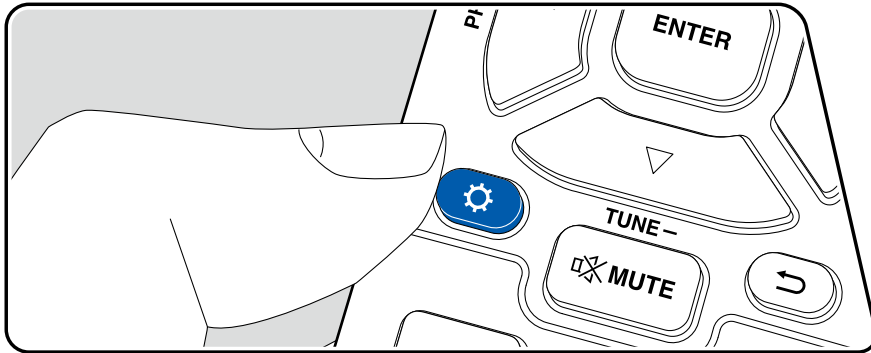

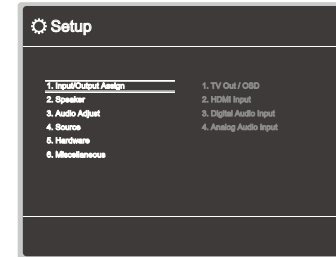

Use the on-screen displays (OSD) that appear on the TV to make the settings. Press  on the remote controller to display the Setup menu.



Select the item with the cursors **▲** / **▼** of the remote controller, and press ENTER to confirm your selection.

Use the cursors **◀** / **▶** to change the default values.

- To return to the previous screen, press .
- To exit the settings, press .

## 1. Input/Output Assign

### ■ 1. TV Out / OSD

Make settings for TV output and On-Screen Displays (OSD) that appear on the TV.

Setting Item	Default Value	Setting Details
1080p -> 4K Upscaling	Off	When using a TV that supports 4K, video signals input at 1080p can be automatically upscaled to 4K for output. "Off": When this function is not to be used "Auto": When this function is to be used • Select "Off" if your TV does not support 4K. • If the TV does not support the 4K resolution with the same frequency as the frequency of HDMI input video signals, upscaling to 4K is not correctly performed. Check the frequency of 4K resolution supported by the TV, and change the resolution of the video signals input from the AV component.
Super Resolution	2	When you have set "1080p -> 4K Upscaling" to "Auto", you can select the degree of video signal correction from "Off" and between "1" (weak) and "3" (strong).
OSD Language	English	Select the on-screen display language from the following. English, German, French, Spanish, Italian, Dutch, Swedish, Russian, Chinese
Impose OSD	On	Set whether or not to display information such as volume adjustment or switching of input on the TV screen. "On": OSD is displayed on the TV. "Off": OSD is not displayed on the TV. • OSD may not be displayed depending on the input signal even if "On" is selected. In this case, change the resolution of the connected device.

Setting Item	Default Value	Setting Details
Mini Player OSD	Always On	You can display on the TV the images from another input selected last while playing the audio from BLUETOOTH input. After switching the input to BLUETOOTH, play the images and audio. And then when you press MODE on the remote controller, the image is displayed in full-screen mode, and the audio information (Mini Player) for BLUETOOTH is displayed in the corner of the screen. You can set whether to always display this Mini Player on the screen. "Always On": The Mini Player is always displayed. "Auto Off": The Mini Player turns off automatically in 30 seconds after displayed. If operation such as changing the volume is performed, it is displayed again for 30 seconds. • Each time the MODE button is pressed, the image display/non-display can be switched. • This setting cannot be selected if "Impose OSD" is set to "Off". • When "OSD Language" is set to Chinese, this function cannot be used.
Screen Saver	3 minutes	Set the time to start the screen saver. Select a value from "3 minutes", "5 minutes", "10 minutes" and "Off".

## ■ 2. HDMI Input

Change input assignment between the input selectors and HDMI IN jacks.

Setting Item	Default Value	Setting Details
BD/DVD	HDMI 1	"HDMI 1" to "HDMI 4": Assign a desired HDMI IN jack to the BD/DVD button. If you do not assign a jack, select "---". To select an HDMI IN jack already assigned to another input selector, change its setting to "---" first.
GAME	HDMI 2	"HDMI 1" to "HDMI 4": Assign a desired HDMI IN jack to the GAME button. If you do not assign a jack, select "---". To select an HDMI IN jack already assigned to another input selector, change its setting to "---" first.
CBL/SAT	HDMI 3	"HDMI 1" to "HDMI 4": Assign a desired HDMI IN jack to the CBL/SAT button. If you do not assign a jack, select "---". To select an HDMI IN jack already assigned to another input selector, change its setting to "---" first.
STRM BOX	HDMI 4	"HDMI 1" to "HDMI 4": Assign a desired HDMI IN jack to the STRM BOX button. If you do not assign a jack, select "---". To select an HDMI IN jack already assigned to another input selector, change its setting to "---" first.
PC	---	"HDMI 1" to "HDMI 4": Assign a desired HDMI IN jack to the PC button. If you do not assign a jack, select "---". To select an HDMI IN jack already assigned to another input selector, change its setting to "---" first.
CD	---	"HDMI 1" to "HDMI 4": Assign a desired HDMI IN jack to the CD button. If you do not assign a jack, select "---". To select an HDMI IN jack already assigned to another input selector, change its setting to "---" first.

Setting Item	Default Value	Setting Details
TV	---	"HDMI 1" to "HDMI 4": Assign a desired HDMI IN jack to the TV button. If you do not assign a jack, select "---". To select an HDMI IN jack already assigned to another input selector, change its setting to "---" first.

### ■ 3. Digital Audio Input

Change input assignment between the input selectors and DIGITAL IN COAXIAL/OPTICAL jacks. If you do not assign a jack, select "---".

Setting Item	Default Value	Setting Details
BD/DVD	---	"COAXIAL", "OPTICAL": Assign a desired DIGITAL IN jack to the BD/DVD button.
GAME	---	"COAXIAL", "OPTICAL": Assign a desired DIGITAL IN jack to the GAME button.
CBL/SAT	---	"COAXIAL", "OPTICAL": Assign a desired DIGITAL IN jack to the CBL/SAT button.
STRM BOX	---	"COAXIAL", "OPTICAL": Assign a desired DIGITAL IN jack to the STRM BOX button.
PC	---	"COAXIAL", "OPTICAL": Assign a desired DIGITAL IN jack to the PC button.
CD	COAXIAL	"COAXIAL", "OPTICAL": Assign a desired DIGITAL IN jack to the CD button.
TV	OPTICAL	"COAXIAL", "OPTICAL": Assign a desired DIGITAL IN jack to the TV button.

- Supported sampling rates for PCM signals (stereo, mono) from a digital input are 32 kHz, 44.1 kHz, 48 kHz, 88.2 kHz, 96 kHz/16 bit, 20 bit, and 24 bit.

### ■ 4. Analog Audio Input

Change input assignment between the input selectors and AUDIO IN jacks. If you do not assign a jack, select "---".

Setting Item	Default Value	Setting Details
BD/DVD	---	"AUDIO 1" to "AUDIO 3": Assign a desired AUDIO IN jack to the BD/DVD button.
GAME	---	"AUDIO 1" to "AUDIO 3": Assign a desired AUDIO IN jack to the GAME button.
CBL/SAT	---	"AUDIO 1" to "AUDIO 3": Assign a desired AUDIO IN jack to the CBL/SAT button.
STRM BOX	---	"AUDIO 1" to "AUDIO 3": Assign a desired AUDIO IN jack to the STRM BOX button.
PC	AUDIO 3	"AUDIO 1" to "AUDIO 3": Assign a desired AUDIO IN jack to the PC button.
AUX	AUDIO 2	"AUDIO 1" to "AUDIO 3": Assign a desired AUDIO IN jack to the AUX button.
CD	AUDIO 1	"AUDIO 1" to "AUDIO 3": Assign a desired AUDIO IN jack to the CD button.
TV	---	"AUDIO 1" to "AUDIO 3": Assign a desired AUDIO IN jack to the TV button.

## 2. Speaker

### ■ 1. Configuration

Change the settings of connection environment of the speakers.

Setting Item	Default Value	Setting Details
Speaker Channels	5.1 ch	Select "2.1 ch", "3.1 ch", "4.1 ch", "5.1 ch", "2.1.2 ch" or "3.1.2 ch" to suit the number of speaker channels connected.
Subwoofer	Yes	Set whether a subwoofer is connected or not. "Yes": When a subwoofer is connected "No": When a subwoofer is not connected
Height Speaker	Top Middle	Set the speaker type if height speakers are connected to the SURROUND or HEIGHT terminals. Select "Top Middle", "Dolby Speaker (Front)" or "Front High" according to the type and layout of the connected speakers. • If the item cannot be selected even though connection is correct, check if the setting in "Speaker Channels" matches the number of connected channels.
Speaker Impedance	6 ohms or above	Set the impedance ( $\Omega$ ) of the connected speakers. "4 ohms": When any of the connected speakers have 4 $\Omega$ or more to less than 6 $\Omega$ impedance "6 ohms or above": When the connected speakers all have 6 $\Omega$ or more impedance • For impedance, check the indications on the back of the speakers or their instruction manual.

### ■ 2. Crossover

Change the settings of crossover frequencies.

Setting Item	Default Value	Setting Details
Front	100 Hz	Select the crossover frequency from "40 Hz" to "200 Hz" to start outputting frequencies for each channel. "Full Band": Full band will be output. • If "Configuration" - "Subwoofer" is set to "No", "Front" is fixed to "Full Band", and the low pitched range of the other channels is output from the front speakers. Refer to the instruction manual of your speakers to make the setting.
Center	100 Hz	Select the crossover frequency from "40 Hz" to "200 Hz" to start outputting frequencies for each channel. "Full Band": Full band will be output. • "Full Band" can be selected only when "Front" is set to "Full Band". • If the item cannot be selected even though connection is correct, check if the setting in "Configuration" - "Speaker Channels" matches the number of connected channels.
Height	100 Hz	Select the crossover frequency from "40 Hz" to "200 Hz" to start outputting frequencies for each channel. "Full Band": Full band will be output. • "Full Band" can be selected only when "Front" is set to "Full Band". • If the item cannot be selected even though connection is correct, check if the setting in "Configuration" - "Speaker Channels" matches the number of connected channels.

Setting Item	Default Value	Setting Details
Surround	100 Hz	<p>Select the crossover frequency from "40 Hz" to "200 Hz" to start outputting frequencies for each channel.</p> <p>"Full Band": Full band will be output.</p> <ul style="list-style-type: none"> <li>"Full Band" can be selected only when "Front" is set to "Full Band".</li> <li>If the item cannot be selected even though connection is correct, check if the setting in "Configuration" - "Speaker Channels" matches the number of connected channels.</li> </ul>
LPF of LFE	120 Hz	<p>Set the low-pass filter for LFE (low-frequency effect) signals in order to pass only the lower frequency signals than the set value, and thus cancel unwanted noises. The low-pass filter is effective only on sources with LFE channel. The value from "80 Hz" to "120 Hz" can be set.</p> <p>"Off": When this function is not used</p>
Double Bass	On	<p>This can be selected only when "Configuration" - "Subwoofer" is set to "Yes" and "Front" is set to "Full Band".</p> <p>Bass output is boosted by feeding bass sounds from the front right and left, and center speakers to the subwoofer.</p> <p>"On": Bass output is boosted.</p> <p>"Off": Bass output is not boosted.</p> <ul style="list-style-type: none"> <li>This function is not automatically set even if AccuEQ Room Calibration is performed.</li> </ul>

### ■ 3. Distance

Set the distance from each speaker to the listening position.

Setting Item	Default Value	Setting Details
Front Left	3.60 m	Specify the distance between each speaker and the listening position.
Center	3.60 m	Specify the distance between each speaker and the listening position.
Front Right	3.60 m	Specify the distance between each speaker and the listening position.
Height Left	2.70 m	Specify the distance between each speaker and the listening position.
Height Right	2.70 m	Specify the distance between each speaker and the listening position.
Surround Right	2.10 m	Specify the distance between each speaker and the listening position.
Surround Left	2.10 m	Specify the distance between each speaker and the listening position.
Subwoofer	3.60 m	Specify the distance between each speaker and the listening position.

- The unit of distance can be changed by pressing the MODE button on the remote controller. When using the unit "feet", the setting is available in increments of 0.1 ft from 0.1 ft to 30.0 ft. When using the unit "meter", the setting is available in increments of 0.03 m from 0.03 m to 9.00 m.



## ■ 4. Level Calibration

Adjust the volume level of each speaker.

Setting Item	Default Value	Setting Details
Front Left	0 dB	Select a value between "-12 dB" and "+12 dB" (in 1 dB increments). A test tone will be output each time you change the value. Select the desired level.
Center	0 dB	Select a value between "-12 dB" and "+12 dB" (in 1 dB increments). A test tone will be output each time you change the value. Select the desired level.
Front Right	0 dB	Select a value between "-12 dB" and "+12 dB" (in 1 dB increments). A test tone will be output each time you change the value. Select the desired level.
Height Left	0 dB	Select a value between "-12 dB" and "+12 dB" (in 1 dB increments). A test tone will be output each time you change the value. Select the desired level.
Height Right	0 dB	Select a value between "-12 dB" and "+12 dB" (in 1 dB increments). A test tone will be output each time you change the value. Select the desired level.
Surround Right	0 dB	Select a value between "-12 dB" and "+12 dB" (in 1 dB increments). A test tone will be output each time you change the value. Select the desired level.
Surround Left	0 dB	Select a value between "-12 dB" and "+12 dB" (in 1 dB increments). A test tone will be output each time you change the value. Select the desired level.
Subwoofer	0 dB	Select a value between "-15 dB" and "+12 dB" (in 1 dB increments). A test tone will be output each time you change the value. Select the desired level.

## ■ 5. Dolby Enabled Speaker

Change the settings of Dolby Enabled Speakers.

Setting Item	Default Value	Setting Details
Dolby Enabled Speaker to Ceiling	1.80 m	Set the distance between the Dolby Enabled Speaker and the ceiling. Select between "0.1 ft/0.03 m" and "15.0 ft/4.50 m" (0.1 ft/0.03 m units). • The unit of distance (ft/m) is displayed using the unit selected for the "Distance" setting.
AccuReflex	Off	You can enhance the reflection effect of Dolby Enabled Speakers from the ceiling. "Off": When this function is not used "On": When this function is used

- This setting can be selected when "Configuration" - "Height Speaker" is set to "Dolby Speaker".

## ■ 6. Speaker Virtualizer

The Speaker Virtualizer function can be switched between On and Off.

Setting Item	Default Value	Setting Details
Speaker Virtualizer	On	"On": Listening modes such as T-D that have virtual speaker effects can be selected. "Off": Listening modes such as T-D that have virtual speaker effects cannot be selected.

## 3. Audio Adjust

### 1. Multiplex/Mono

Change the settings of multiplex audio playback.

Setting Item	Default Value	Setting Details
Multiplex Input Channel	Main	Set the audio channel or language to be output when playing multiplex audio or multilingual broadcasts, etc. "Main": Main channel only "Sub": Sub channel only "Main/Sub": Main and sub channels are output at the same time. • For multiplex audio broadcasts, pressing the <b>i</b> button on the remote controller will display "1+1" on the main unit's display.
Mono Input Channel	Left + Right	Set the input channel to play 2-ch digital sources such as Dolby Digital, or 2-ch analog/PCM sources in the Mono listening mode. "Left": Left channel only "Right": Right channel only "Left + Right": Left and right channels

### 2. Dolby

Change the setting of when Dolby signals are input.

Setting Item	Default Value	Setting Details
Loudness Management	On	When playing Dolby TrueHD, enable the dialog normalization function which keeps the volume of dialog at a certain level. Note that when this setting is Off, the Late Night function that allows you to enjoy surround at low volumes is fixed to off when playing Dolby Digital Plus/Dolby TrueHD. "On": When this function is used "Off": When this function is not used

### 3. DTS

Change the setting of when DTS signals are input.

Setting Item	Default Value	Setting Details
DTS Auto Surround	On	When inputting DTS signals that include extended channel information, the optimum listening mode is automatically selected according to the extended information contained in the input signal and the speaker configuration of this unit when playing in the straight decoding listening mode. "On": When this function is used "Off": Audio is played using the same number of channels in the input signal according to the speaker configuration of this unit.
Dialog Control	0 dB	You can increase the volume of dialog portion of the audio up to 6 dB by 1 dB step so that you can hear the dialog easily in noisy atmosphere. • This cannot be set for content other than DTS:X. • Depending on the content, this function may not be selected.

### 4. LFE Level

Set the low-frequency effect (LFE) level for Dolby Digital series, DTS series, Multichannel PCM, and DSD signals.

Setting Item	Default Value	Setting Details
LFE Level	0 dB	Select the low-frequency effect (LFE) level of each signal from "0 dB" to "-∞ dB". If the low-frequency effect sound is too strong, select "-20 dB" or "-∞ dB".

## ■ 5. Volume

Change the Volume settings.

Setting Item	Default Value	Setting Details
Mute Level	-∞ dB	Set the volume lowered from the listening volume when muting is on. Select a value from "-∞ dB", "-40 dB" and "-20 dB".
Maximum Volume	Off	Set the maximum value to prevent the volume from becoming too loud. Select a value from "Off", and "50" to "99".
Power On Volume	Last	Set the volume level of when the power is turned on. Select a value from "Last" (Volume level before entering standby mode), "Min", "1" to "99" and "Max". <ul style="list-style-type: none"> <li>You cannot set a higher value than that of "Maximum Volume".</li> </ul>
Headphone Level	0 dB	Adjust the output level of headphones. Select a value between "-12 dB" and "+12 dB".

## 4. Source

### ■ 1. IntelliVolume

Adjust the volume level when there are differences in volume level among multiple devices connected to this unit. Select the input selector to make the setting.

Setting Item	Default Value	Setting Details
IntelliVolume	0 dB	Select a value between "-12 dB" and "+12 dB". Set a negative value if the volume of the target device is larger than the others and a positive value if smaller. To check the audio, play back the connected device. <ul style="list-style-type: none"> <li>This function does not work in Zone B.</li> </ul>

### ■ 2. Name Edit

Set an easy name for each input. The set name appears on the main unit's display. Select the input selector to make the setting.

Setting Item	Default Value	Setting Details
Name Edit	Input name	<ol style="list-style-type: none"> <li>Select a character or symbol with the cursors, and press ENTER. Repeat this operation to input up to 10 characters. "A/a": Switches between upper and lower cases. (Pressing MODE on the remote controller also toggles between upper and lower cases) "←" "→": Moves the cursor in the arrow direction. "⊗": Removes a character on the left of the cursor. "Space": Enters a space.                             <ul style="list-style-type: none"> <li>Pressing CLEAR on the remote controller will remove all the input characters.</li> </ul> </li> <li>After inputting, select "OK" with the cursors, and press ENTER. The input name will be saved. To restore the name to the default value, press CLEAR on the remote controller on the input screen. Then while nothing is entered, select "OK", and press ENTER.</li> </ol>

- To name a preset radio station (FM), press TUNER on the remote controller, select FM, and select the preset number.
- This cannot be set if the "BLUETOOTH" input is selected.

## ■ Audio Select

Select the priority for input selection when multiple audio sources are connected to one input selector. The setting can be made for each input selector button. Select the input selector to make the setting. Note that some of the default values cannot be changed.

Setting Item	Default Value	Setting Details
Audio Select	BD/DVD: HDMI GAME: HDMI CBL/SAT: HDMI STRM BOX: HDMI PC: Analog CD: COAXIAL TV: OPTICAL	<p>"ARC": When giving priority to the input signal from ARC-compatible TV.</p> <ul style="list-style-type: none"> <li>This item can be selected only when "5. Hardware" - "HDMI" - "Audio Return Channel" is set to "On" and also the "TV" input is selected.</li> </ul> <p>"HDMI": When giving priority to the input signal from HDMI IN jacks</p> <ul style="list-style-type: none"> <li>This item can be selected only when the input to be set is assigned to the HDMI jack in the "1. Input/Output Assign" - "HDMI Input" setting.</li> </ul> <p>"COAXIAL": When giving priority to the input signal from DIGITAL IN COAXIAL jacks</p> <ul style="list-style-type: none"> <li>This item can be selected only when the input to be set is assigned to the COAXIAL jack in the "1. Input/Output Assign" - "Digital Audio Input" setting.</li> </ul> <p>"OPTICAL": When giving priority to the input signal from DIGITAL IN OPTICAL jacks</p> <ul style="list-style-type: none"> <li>This item can be selected only when the input to be set is assigned to the OPTICAL jack in the "1. Input/Output Assign" - "Digital Audio Input" setting.</li> </ul> <p>"Analog": When giving priority to the input signal from AUDIO IN jacks</p> <ul style="list-style-type: none"> <li>This item can be selected only when the input to be set is assigned to the AUDIO IN jack in the "1. Input/Output Assign" - "Analog Audio Input" setting.</li> </ul>

Setting Item	Default Value	Setting Details
PCM Fixed Mode	Off	<p>Select whether to fix input signals to PCM (except multi-channel PCM) when you select "HDMI", "COAXIAL", or "OPTICAL" in the "Audio Select" setting. Set this item to "On" if noise is produced or truncation occurs at the beginning of a track when playing PCM sources. Select "Off" normally.</p> <ul style="list-style-type: none"> <li>Each time the "Audio Select" setting is changed, the setting is restored to "Off".</li> </ul>

- The setting cannot be changed when "TUNER" or "BLUETOOTH" input is selected.

## ■ Video Select

When "TUNER" or "BLUETOOTH" input is selected, you can set the input from which video is displayed on the TV.

Setting Item	Default Value	Setting Details
Video Select	Last	<p>"Last": Select the video input played last.</p> <p>"BD/DVD", "GAME", "CBL/SAT", "STRM BOX", "PC", "CD", "TV": Play the video of each input.</p> <ul style="list-style-type: none"> <li>This setting is effective for an input selector assigned in "1. Input/Output Assign" - "HDMI Input".</li> </ul>

- If the OSD language is set to Chinese, you can select this setting only when "TUNER" is selected as input.

## 5. Hardware

### 1. HDMI

Change the settings of the HDMI function.

Setting Item	Default Value	Setting Details
HDMI CEC	Off	<p>Setting this to "On" enables the input selection link and other link functions with HDMI-connected CEC-compatible device.</p> <p>"On": When this function is used                      "Off": When this function is not used</p> <p>When this setting is changed, turn off and then on again the power of all connected devices.</p> <ul style="list-style-type: none"> <li>Depending on the TV to use, a link setting may be required on the TV.</li> <li>Setting this to "On" and closing the operation screen will display the name of the connected CEC-compatible device and "CEC On" on the main unit's display.</li> <li>When this is set to "On", the power consumption in standby mode may increase. (Depending on the TV status, the unit will enter the normal standby mode.)</li> <li>If you operate the MASTER VOLUME dial on the main unit when this setting is "On" and audio is output from the TV speakers, audio will be output also from the speakers connected to this unit. To output audio from only either of them, change the setting of this unit or TV, or reduce the volume of this unit.</li> <li>If abnormal behavior is observed when this is set to "On", set it to "Off".</li> <li>If a connected device is not CEC-compatible, or if you are not sure whether it is compatible, set it to "Off".</li> </ul>

Setting Item	Default Value	Setting Details
HDMI Standby Through	Off	<p>When this is set to anything other than "Off", you can play the video and audio of an HDMI-connected player on the TV even if the unit is in standby mode. Also, only "Auto" and "Auto(Eco)" can be selected if "HDMI CEC" is set to "On". If you select anything else, set "HDMI CEC" to "Off".</p> <ul style="list-style-type: none"> <li>The power consumption in standby mode will increase if it is set to anything other than "Off".</li> </ul> <p>"BD/DVD", "GAME", "CBL/SAT", "STRM BOX", "PC", "CD", "TV": For example, if you select "BD/DVD", you can play the device connected to the "BD/DVD" jack on the TV even if the unit is in standby mode. Select this setting if you have decided which player to use with this function.</p> <p>"Last": You can play on the TV the video and audio of the input selected immediately before the unit is switched to standby.</p> <p>"Auto", "Auto (Eco)": Select either of the settings if the connected player conforms to the CEC standard. You can play the video and audio of the player on the TV using the CEC link function, irrespective of what input is selected immediately before the unit is switched to standby.</p> <ul style="list-style-type: none"> <li>To play a non-CEC compliant player on the TV, turn the unit on and switch the input.</li> <li>When using a CEC-compliant TV, you can reduce the power consumption in standby mode by selecting "Auto (Eco)".</li> </ul>

Setting Item	Default Value	Setting Details
Audio TV Out	Off	<p>You can enjoy audio through the speakers of the TV while this unit is on.</p> <p>"On": When this function is used                      "Off": When this function is not used</p> <ul style="list-style-type: none"> <li>• Listening mode cannot be changed while "Audio TV Out" is set to "On" and audio is being output from the TV.</li> <li>• Depending on your TV or input signal of the connected device, audio may not be output from the TV even if this is set to "On". In such a case, audio is output from the speakers of the unit.</li> <li>• Audio is output from this unit if you operate the MASTER VOLUME dial on this unit when audio that is input to this unit is output from your TV speakers. If you do not want to output audio, change the setting of this unit or TV, or reduce the volume of this unit.</li> </ul>
Audio Return Channel	Off	<p>You can enjoy the sound of the HDMI-connected ARC-compatible TV through the speakers connected to the unit.</p> <p>"On": When enjoying the TV sound through the speakers of this unit                      "Off": When not using the ARC function</p>
Auto Lip Sync	On	<p>This setting automatically corrects desynchronization between the video and audio signals based on the information from the HDMI Lip Sync-compatible TV.</p> <p>"On": When enabling the automatic correction function                      "Off": When not using the automatic correction function</p>

## 2. Bluetooth

Change the settings for the Bluetooth function.

Setting Item	Default Value	Setting Details
Bluetooth	On	<p>Select whether or not to use the BLUETOOTH function.</p> <p>"On": Enables connection with a BLUETOOTH-enabled device by using the BLUETOOTH function. Select "On" also when making various BLUETOOTH settings.                      "Off": When not using the BLUETOOTH function</p>
Auto Input Change	On	<p>When a BLUETOOTH-enabled device is played while it is connected to the unit, the input of the unit can be automatically switched to "BLUETOOTH".</p> <p>"On": The input is automatically set to "BLUETOOTH" responding to the playback operation of the BLUETOOTH-enabled device.                      "Off": The function is disabled.</p> <ul style="list-style-type: none"> <li>• If the input is not switched automatically, set this to "Off", and change the input manually.</li> </ul>
Auto Reconnect	On	<p>This function automatically reconnects to the BLUETOOTH-enabled device connected last when you change the input to "BLUETOOTH".</p> <p>"On": When this function is used                      "Off": When this function is not used</p> <ul style="list-style-type: none"> <li>• This may not work with some BLUETOOTH-enabled devices.</li> </ul>

Setting Item	Default Value	Setting Details
Pairing Information	-	You can initialize the pairing information stored on this unit. Pressing ENTER when "Clear" is displayed initializes the pairing information stored on this unit. <ul style="list-style-type: none"> <li>This function does not initialize the pairing information on the BLUETOOTH-enabled device. When pairing the unit again with the device, be sure to clear the pairing information on the BLUETOOTH-enabled device beforehand. For information on how to clear the pairing information, refer to the instruction manual of the BLUETOOTH-enabled device.</li> </ul>
Device	-	Displays the name of the BLUETOOTH-enabled device connected to the unit. <ul style="list-style-type: none"> <li>The name is not displayed when "Status" is "Ready" and "Pairing".</li> </ul>
Status	-	Displays the status of the BLUETOOTH-enabled device connected to the unit. "Ready": Not paired "Pairing": Paired "Connected": Successfully connected

- Wait for a while if "Bluetooth" cannot be selected. It can be selected when the BLUETOOTH function is activated.

### ■ 3. Power Management

Change the settings for the power-save function.

Setting Item	Default Value	Setting Details
Sleep Timer	Off	You can allow the unit to enter standby automatically when the specified time elapses. Select a value from "30 minutes", "60 minutes" and "90 minutes". "Off": The unit does not automatically enter standby mode.

Setting Item	Default Value	Setting Details
Auto Standby	On	This setting allows the unit to enter standby mode automatically after 20 minutes of inactivity without any video or audio input. (When "USB Power Out at Standby" is enabled, the unit enters the HYBRID STANDBY mode which minimizes the increase in power consumption.) "On": The unit automatically enters standby mode ("AUTO STBY" lights up). "Off": The unit does not automatically enter standby mode. <ul style="list-style-type: none"> <li>"Auto Standby" is displayed on the main unit's display and TV screen 30 seconds before entering standby mode.</li> </ul>
Auto Standby in HDMI Standby Through	On	Enable or disable "Auto Standby" while "HDMI Standby Through" is on. "On": The setting is enabled. "Off": The setting is disabled. <ul style="list-style-type: none"> <li>This setting cannot be set to "On" if "Auto Standby" and "HDMI Standby Through" are set to "Off".</li> </ul>
USB Power Out at Standby	Off	When this function is set to "On", electricity can be supplied to the Streaming media player connected to the POWER OUT port even if this unit is in standby mode. <ul style="list-style-type: none"> <li>The POWER OUT jack is cannot supply power to smart phones/tablets or other devices.</li> <li>While using this function, power consumption increases in standby mode, however, the increase in power consumption is minimized by automatically entering the HYBRID STANDBY mode where only the essential circuits are operating.</li> </ul>

## 6. Miscellaneous

### ■ 1. Tuner

Change the settings for TUNER.

Setting Item	Default Value	Setting Details
FM Search Level	Normal	If automatic tuning regularly stops on FM stations with weak reception when "Normal" is selected, select "Strong" so only those FM stations with strong reception are selected.
DAB Auto Scan	-	You can run the auto scan when new DAB stations are added or when you move house.
DAB DRC	Off	With the DRC (Dynamic Range Control) setting, you can reduce the dynamic range of DAB digital radio so that you can still hear quiet parts even when listening at low volume levels - ideal for listening to the radio late at night when you don't want to disturb anyone. "Off": DRC off "Large": Large reduction in dynamic range "Small": Small reduction in dynamic range

### ■ 2. Firmware Update

Change the settings for Firmware Update.

Setting Item	Default Value	Setting Details
Version	-	The current firmware version is displayed.
Update via USB	-	Press ENTER to select when updating the firmware via USB.

### ■ 3. Initial Setup

Make the initial setup from the setup menu.

### ■ 4. Lock

Lock the Setup menu so that the settings cannot be changed.

Setting Item	Default Value	Setting Details
Setup Parameter	Unlocked	Lock the Setup menu so that the settings cannot be changed. "Locked": The menu is locked. "Unlocked": The menu is unlocked.



## Quick Menu

### Menu operations

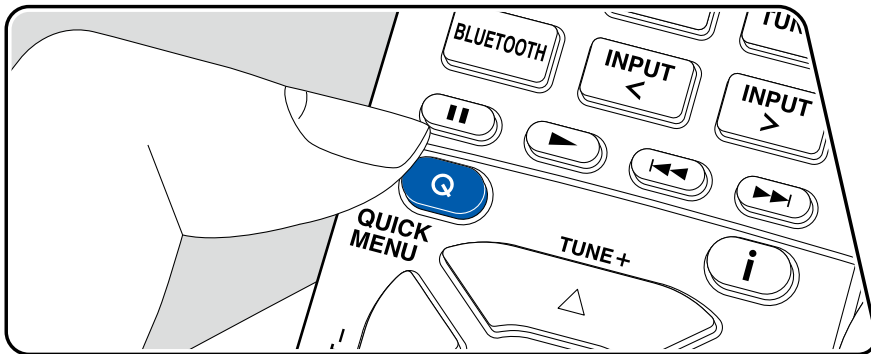

You can quickly adjust the settings you frequently use, such as tone adjustments, etc.

You can make the settings on the TV screen during playback. Press Q on the remote controller to display the Quick Menu.

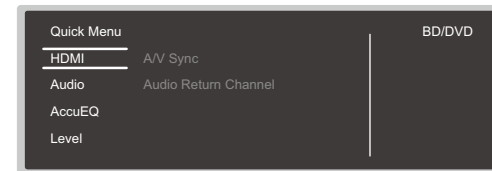

Select the item with the cursors ▲ / ▼ of the remote controller, and press ENTER to confirm your selection.

Use the cursors to change the settings.

- To return to the previous screen, press ↵.
- To exit the settings, press Q.

### ■ HDMI

**AV Sync:** If the video is behind the audio, you can delay the audio to offset the gap. The setting can be set for each input.

- It cannot be set if the listening mode is Direct.

**Audio Return Channel:** You can enjoy the sound of the HDMI-connected ARC-compatible TV through the speakers connected to the unit. Select "On" when listening to the audio of TV using the speakers of this unit. Select "Off" when the ARC function is not used.

## ■ Audio

**Music Optimizer:** Improve the quality of the compressed audio. Playback sound of lossy compressed files such as MP3 will be improved. The setting can be set for each input. This works in signals whose sampling frequencies are 48 kHz or less. The setting is not effective in the bitstream signals.

- It cannot be set if the listening mode is Direct.

**Late Night:** Enable small sounds to be easily heard in detail. It is useful when you need to reduce the volume while watching a movie late night. You can enjoy the effect only when playing the Dolby series and DTS series input signals.

- This function cannot be used in the following cases.
  - When playing Dolby Digital Plus or Dolby TrueHD with "Loudness Management" set to "Off"
  - When the input signal is DTS:X, and "Dialog Control" is not 0 dB
- If you set the unit to the standby mode, the adjustments you made will be restored to the previous statuses.

## ■ AccuEQ

**AccuEQ:** Enable or disable the equalizer function that corrects for sound distortion caused by the acoustic environment of the room. To enable this setting, normally select "On (All Ch)", and to disable only the front speakers, select "On (ex. L/R)". The setting can be set for each input.

**Cinema Filter:** Adjusts the soundtrack with the enhanced high range so that it suits a home theater.

In this function, the following listening modes can be used: Dolby Audio - DD, Dolby Audio - DD+, Dolby Audio - Surr, Dolby Audio - TrueHD, Multichannel, DTS, DTS-ES, DTS 96/24, DTS-HD High Resolution, DTS-HD Master Audio, DTS Neural:X, DTS Express and DSD.

- It cannot be set if the listening mode is Direct.

## ■ Level

**Front:** Adjust the speaker level of the front speaker while listening to the sound.

**Center:** Adjust the speaker level of the center speaker while listening to the sound.

**Subwoofer:** Adjust the speaker level of the subwoofer while listening to the sound.

- If you set the unit to the standby mode, the adjustments you made will be restored to the previous statuses.

## Initial Setup with Auto Start-up Wizard

### Operations

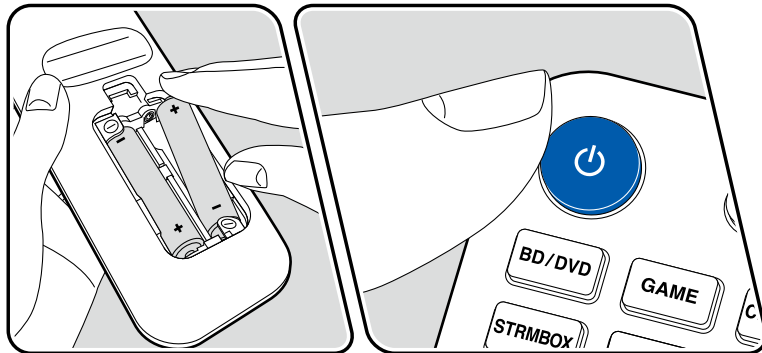
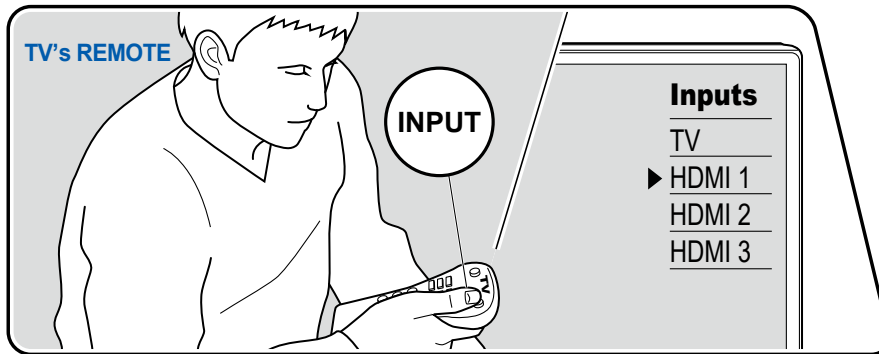

When you turn the unit on for the first time after purchase, the Initial Setup screen is automatically displayed on the TV to allow you to make settings required for startup using simple operations following on-screen guidance.

1. Switch the input of the TV to the input connected to the unit.
  2. Put batteries into the remote controller of this unit.
  3. Press **⏻** on the remote controller to turn the unit on.
  4. When the language selection screen is displayed on TV, select the language with the cursors **▲ / ▼** and press **ENTER**.
    - Select the item with the cursors of the remote controller, and press **ENTER** to confirm your selection. To return to the previous screen, press **↶**.
    - If you have terminated the Initial Setup halfway, turn this unit to standby mode. Then turning the power on again can display the Initial Setup again.
- The Initial Setup appears on the screen each time the power is turned on unless the Initial Set up is completed or "Never Show Again" is selected on the first screen.
- To perform the Initial Setup again after the setting is completed, press **⚙️**, select "6. Miscellaneous" - "Initial Setup", and press **ENTER**.

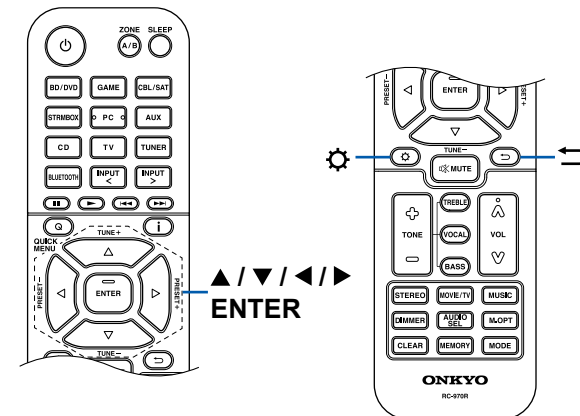

## ■ 1. Speaker Setup

1. Select the connected speaker configuration, and press ENTER.  
Note that the image on the screen changes each time you select the number of channels in "Speaker Channels".

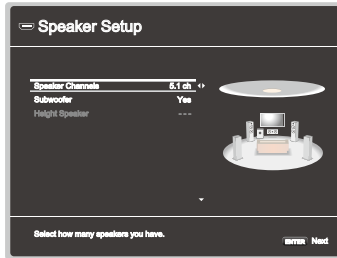

2. The speaker combination selected in step 1 is displayed. "Yes" is displayed for the selected speakers. If the setting is correct, press ENTER.
3. Select "Next" and press ENTER. Then a test tone is output from each speaker to confirm the connection. Selecting each speaker with the cursors ▲ / ▼ will output the test tone. Press ENTER after confirmation.
4. If there is no problem with the speaker connection, select "Next" and press ENTER. To return to "Speaker Setup", select "Back to Speaker Setup" and press ENTER.

## ■ 2. AccuEQ Room Calibration

Place the supplied speaker setup microphone at the listening position. The unit automatically measures the test tones output from each speaker, and sets the optimum volume level for each speaker, the crossover frequencies, and the distance from the listening position. This also automatically adjusts the equalizers for the speakers, and enables correction of sound distortion caused by the acoustic environment of the room.

- It takes between 3 and 12 minutes for calibration to be completed. Each speaker outputs the test tone at high volume during measurement, so be careful of your surroundings. Also, keep the room as quiet as possible during measurement.
- If you connect a subwoofer, check the power and volume of the subwoofer. Set the subwoofer volume to more than half.

- If the power of this unit suddenly turns off, the wires in the speaker cables have touched the rear panel or other wires, and the protection circuit is working. Twist the wires again securely, and make sure they do not stick out of the speaker terminals when connecting.

1. Place the supplied speaker setup microphone at the listening position, and connect it to the SETUP MIC jack on the main unit.

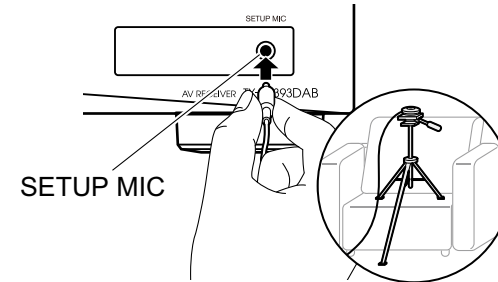

When placing the speaker setup microphone on a tripod, refer to the illustration.

2. Confirm a test tone is output from the subwoofer and press ENTER.
3. Press ENTER. Then, test tones are output from each speaker, and the connected speakers and the noise in the surrounding environment are automatically measured.
4. The measurement results in step 3 are displayed. Select "Next", and press ENTER. The test tones are output again. Then, the unit automatically sets the optimum volume level, crossover frequency, etc.
5. When the measurement is completed, the measurement results are displayed. You can check each setting using the cursors ◀ / ▶. Select "Save" and press ENTER to save the settings.
6. Disconnect the speaker setup microphone.

## ■ 3. ARC Setup

To connect with an ARC-compatible TV, select "Yes". The ARC setting on this unit turns on, and you can listen to the TV's audio through this unit.

- If you select "Yes", the HDMI CEC function is enabled and power consumption increases during standby.

## Troubleshooting

### Before starting the procedure

Problems may be solved by simply turning the power on/off or disconnecting/connecting the power cord, which is easier than working on the connection, setting and operating procedure. Try the simple measures on both the unit and the connected device. If the problem is that the video or audio is not output or the HDMI linked operation does not work, disconnecting/connecting the HDMI cable may solve it. When reconnecting, be careful not to wind the HDMI cable since if wound the HDMI cable may not fit well. After reconnecting, turn off and on the unit and the connected device.

- The AV receiver contains a microPC for signal processing and control functions. In very rare situations, severe interference, noise from an external source, or static electricity may cause it to lockup. In the unlikely event that this happens, unplug the power cord from the wall outlet, wait at least 5 seconds, and then plug it back in.
- Our company is not responsible for damages (such as CD rental fees) due to unsuccessful recordings caused by the unit's malfunction. Before you record important data, make sure that the material will be recorded correctly.

### When the unit is operating erratically 86

Try restarting the unit 86

Resetting the unit  
(this resets the unit settings to the default) 86

### Troubleshooting 87

■ Power 87

■ Audio 87

■ Listening Modes 89

■ Video 90

■ Linked operation 90

■ FM broadcasting 91

■ BLUETOOTH function 91

■ ZONE B function 92

■ Remote Controller 92

■ Display 92

■ Others 92

## When the unit is operating erratically

### ❑ Try restarting the unit

Restarting this unit may solve the problem. After turning the unit to standby mode, press and hold the  $\odot$  ON/STANDBY button of the main unit for at least 5 seconds, and then restart the unit. (The settings on this unit are kept.) If the problem persists after restarting the unit, unplug and plug the power cords or HDMI cable of this unit and connected devices.

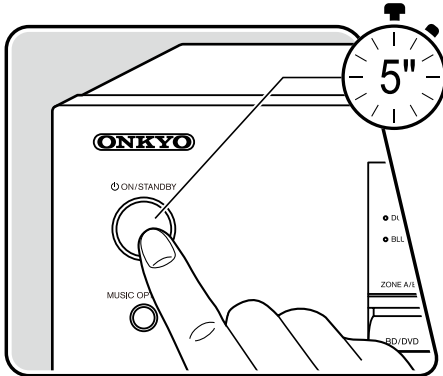

### ❑ Resetting the unit (this resets the unit settings to the default)

If the restart of the unit does not solve the problem, reset the unit, and restore all the settings to the factory default at the time of purchase. This may solve the problem. If the unit is reset, your settings are restored to the default values. Be sure to note down your setting contents before performing the following operations.

1. While pressing and holding CBL/SAT of the input selector on the main unit with the unit turned on, press the  $\odot$  ON/STANDBY button.
2. "Clear" is displayed on the display, and the unit returns to the standby state. Do not remove the power cord until "Clear" disappears from the display.

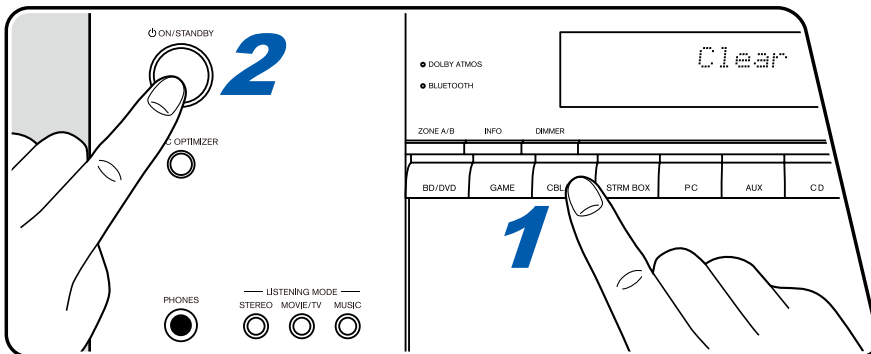

## Troubleshooting

### ■ Power

#### ❑ When the power is turned on, "AMP Diag Mode" appears on the display of the main unit.

- The protection circuit function may have operated. If the unit suddenly enters the standby state and "AMP Diag Mode" appears on the display of the main unit when the power is turned on again, this function is diagnosing whether or not the main unit is malfunctioning or there is an abnormality with the speaker cable connection. When the diagnosis is complete, the following messages are displayed.

CH SP WIRE	If the unit returns to the normal ON state after "CH SP WIRE" appears on the display, the speaker cable may have been short-circuited. After setting the power of this unit to standby state, connect the speaker cable again. Twist the wires exposed from the tip of the speaker cable so that the wires do not stick out of the speaker terminal.
NG: *****	If the operation has stopped with "NG" displayed on the display, set the power of this unit to standby state immediately and remove the power plug from the outlet. The unit may be malfunctioning. Consult a dealer.

#### ❑ The unit turns off unexpectedly

- If "5. Hardware" - "Power Management" - "Auto Standby" on the Setup menu is activated, the unit automatically enters the standby mode. (→p79)
- The protection circuit function may have operated due to an abnormal rise in temperature of the unit. In such a case, the power turns off repeatedly even if the power is turned on each time. Secure sufficient ventilation space around the unit, wait for a while until the temperature of the unit decreases. Then, turn the power on again.

**WARNING:** If smoke, smell or abnormal noise is produced by the unit, unplug the power cord from the outlet immediately, and contact the dealer or our company's Support.

### ■ Audio

- Make sure that the speaker setup microphone is no longer connected.
- Confirm that the connection between the output jack on the connected device and the input jack on this unit is correct.
- Make sure that none of the connecting cables are bent, twisted, or damaged.
- If the MUTE indicator on the display blinks, press  on the remote controller to cancel muting.
- While headphones are connected to the PHONES jack, no sound is output from the speakers.
- When "4. Source" - "Audio Select" - "PCM Fixed Mode" in the Setup menu is set to "On", no sound is played if signals other than PCM are input.

Change the setting to Off.

Check the following if the problem persists after you have confirmed the above.

## ❑ No sound from the TV

- Change the input selector on this unit to the position of the terminal to which the TV is connected.
- If the TV does not support the ARC function, along with the connection by an HDMI cable, connect the TV with this unit using a digital optical cable. (→[p28](#))

## ❑ No sound from a connected player

- Change the input selector on this unit to the position of the terminal to which the player is connected.
- Check the digital audio output setting on the connected device. On some game consoles, such as those supporting DVD, the default setting may be off.
- For some DVD-Video discs, you need to select an audio output format from a menu.

## ❑ A speaker produces no sound

- Make sure that the polarity (+/-) of the speaker cables is correct, and that no bare wires are in contact with the metal part of speaker terminals. (→[p21](#))
- Make sure that the speaker cables are not shorting out.
- Check "Connect the Speaker Cables" (→[p21](#)) to see if the speaker connections have been made correctly. Settings for the speaker connection environment need to be made in "Speaker Setup" in Initial Setup. Check "Initial Setup with Auto Start-up Wizard" (→[p83](#)).
- Depending on the input signal and listening mode, not much sound may be output from speakers. Select another listening mode to see if sound is output.

## ❑ The subwoofer produces no sound

If the setting of the front speakers is "Full Band", the low range elements will be output from the front speakers instead of from the subwoofer during 2 ch audio input of TV or music. To output the sound from the subwoofer, make one of the following settings.

1. Change the setting for the front speakers to a setting of crossover frequency value other than "Full Band".  
The range below the specified frequency will be output from the subwoofer instead of from the front speakers. If your front speakers have a high low-range reproduction capability, changing this setting is not recommended.
  2. Change "Double Bass" to "On".  
The low range elements of the front speakers will be output from both the front speakers and the subwoofer. Due to this, the bass sound may be emphasized too much. In such a case, do not change the setting, or make the setting with the above option 1.
- For the setting details, refer to "2. Speaker" - "Crossover" in the Setup menu. (→[p71](#))
  - If the input signals do not contain subwoofer audio elements (LFE), the subwoofer may produce no sound.

## ❑ Noise can be heard

- Using cable ties to bundle audio pin cables, power cords, speaker cables, etc. may degrade the audio performance. Do not bundle the cords.
- An audio cable may be picking up interference. Change the position of the cables.



### ❑ The beginning of audio received by an HDMI IN cannot be heard

- Since it takes longer to identify the format of an HDMI signal than it does for other digital audio signals, audio output may not start immediately.

### ❑ Sound suddenly reduces

- When using the unit for extended periods with the temperature inside the unit exceeding a certain temperature, the volume may be reduced automatically to protect the circuits.

## ■ Listening Modes

- To enjoy digital surround playback in formats such as Dolby Digital, you need to make a connection for audio signals with an HDMI cable, digital coaxial cable or digital optical cable. Also, audio output need to be set to Bitstream output on the connected Blu-ray Disc player, etc.
- Press **i** on the remote controller several times to switch the display of the main unit, and you can check the input format. When using a BLUETOOTH connection, press the INFO button on the main unit.

Check the following if the problem persists after you have confirmed the above.

### ❑ Cannot select a desired listening mode

- Depending on the connection status of the speaker, some listening modes may not be selected. Refer to "Speaker Layouts and Selectable Listening Modes" (→[p51](#)) or "Input Formats and Selectable Listening Modes" (→[p57](#)) in "Listening Mode".

### ❑ Cannot listen to the sound in Dolby TrueHD, Dolby Atmos or DTS-HD Master Audio format

- If the audio in Dolby TrueHD, Dolby Atmos or DTS-HD Master Audio format cannot be output correctly in the source format, set "BD video supplementary sound" (or reencode, secondary sound, video additional audio, etc.) to "Off" in the setting of a connected Blu-ray Disc player, etc. After changing the setting, switch the listening mode to that for each source, and confirm.

### ❑ About DTS signals

- With media that switches suddenly from DTS to PCM, PCM playback may not start immediately. In such a case, stop playback on the player side for approx. 3 seconds or more. Then, resume playback. The playback will be performed normally.
- DTS playback may not be performed normally on some CD and LD players even if the player and this unit are digitally connected. If some processing (e.g., output level adjustment, sampling frequency conversion, or frequency characteristic conversion) has been executed for the DTS signal being output, this unit cannot recognize it as a genuine DTS signal, and noise may occur.
- While playing a DTS-compatible disc, if a pause or skip operation is performed on your player, noise may occur for a short period. This is not a malfunction.

## ■ Video

- Confirm that the connection between the output jack on the connected device and the input jack on this unit is correct.
  - Make sure that none of the connecting cables are bent, twisted, or damaged.
  - When the TV image is blurry or unclear, the power cord or connection cables of the unit may have interfered. In such a case, keep distance between TV antenna cable and cables of the unit.
  - Check the switching of the input screen on the monitor side such as a TV.
- Check the following if the problem persists after you have confirmed the above.

### □ No image appears

- Change the input selector on this unit to the position of the terminal to which the player is connected.

### □ No image from a device connected to HDMI IN jack

- To display video from the connected player on the TV while the unit is in standby, you need to enable "5. Hardware" - "HDMI" - "HDMI Standby Through" in the Setup menu. For details of the HDMI Standby Through function, refer to "5. Hardware" - "HDMI" in the Setup menu. (→p77)
- Check if "Resolution Error" is displayed on the main unit display when video input via HDMI IN jack is not displayed. In this case, the TV does not support the resolution of the video input from the player. Change the setting on the player.
- Normal operation with an HDMI-DVI adapter is not guaranteed. In addition, video signals output from a PC are not guaranteed.

### □ Images flicker

- The output resolution of the player may not be compatible with the resolution of the TV. If the player is connected to this unit with an HDMI cable, change the output resolution on the player. Also this may be solved by changing the screen mode on the TV.

### □ Video and audio are out of synch

- Depending on the settings on your TV and connection environment, the video may be behind the audio. Press Q on the remote controller to display "Quick Menu", select "HDMI" - "A/V Sync", and make the adjustment. (→p81)

## ■ Linked operation

### □ HDMI linked operation does not work with CEC-compliant devices, such as a TV

- In the Setup menu of the unit, set "5. Hardware" - "HDMI" - "HDMI CEC" to "On". (→p77)
- It is also necessary to set HDMI linking on the CEC-compliant device. Check the instruction manual.

## ■ FM broadcasting

### □ Poor reception or much noise

- Recheck the antenna connection.
- Move the antenna away from the speaker cord or power cord.
- Move the unit away from your TV or PC.
- Passing cars or airplanes in the vicinity can cause interference.
- If radio waves are blocked by concrete walls, etc., radio reception may be poor.
- Change the reception mode to mono ( →p38).
- FM reception may be clearer if you use the antenna jack on the wall used for the TV.

( →p32)

## ■ BLUETOOTH function

- Unplug and plug the power cord of the unit, or turn off and on the BLUETOOTH-enabled device. Restart of the BLUETOOTH-enabled device may be effective.
- BLUETOOTH-enabled devices must support the A2DP profile.
- Because a radio wave interference will occur, this unit may not be used near devices such as a microwave oven or cordless phone which use the radio wave in the 2.4 GHz range.
- A metallic object near the unit can affect on the radio wave, and BLUETOOTH connection may not be possible.

Check the following if the problem persists after you have confirmed the above.

### □ Cannot connect with this unit

- Check if the BLUETOOTH function of the BLUETOOTH-enabled device is enabled.

( →p78)

### □ Music playback is unavailable on the unit even after successful BLUETOOTH connection

- When the audio volume of your BLUETOOTH-enabled device is set low, the audio may not be played back. Turn up the volume of the BLUETOOTH-enabled device.
- Depending on the BLUETOOTH-enabled device, the Send/Receive selector switch may be equipped. Select Send mode.
- Depending on the characteristics or specifications of the BLUETOOTH-enabled device, music may not be played back on this unit.

### □ Sound is interrupted

- There may a problem with the BLUETOOTH-enabled device. Check the information on a web page.

### □ The audio quality is poor after connection with a BLUETOOTH-enabled device

- The BLUETOOTH reception is poor. Move the BLUETOOTH-enabled device closer to the unit, or remove any obstacle between the BLUETOOTH-enabled device and this unit.

## ■ ZONE B function

### ❑ Cannot ZONE B-output the audio of externally connected AV components

- To output audio to ZONE B, set the audio output destination to "ZONE A+B" or "ZONE B".

( →p44)

## ■ Remote Controller

- Make sure that the batteries are inserted with the correct polarity.
- Insert new batteries. Do not mix different types of batteries, or old and new batteries.
- Make sure that the sensor of the main unit is not subjected to direct sunlight or inverter-type fluorescent lights. Relocate it if necessary.
- If the main unit is installed in a rack or cabinet with colored-glass doors, or if the doors are closed, the remote controller may not work normally.

## ■ Display

### ❑ The display does not light up

- When the Dimmer function is working, the display may go dim. Press the DIMMER button, and change the brightness level of the display.

( →p9)

## ■ Others

### ❑ Strange noise can be heard from the unit

- If you have connected another device to the same outlet as this unit, strange noise may occur under the influence of the device. If the symptom is remedied by removing the power plug of the other device from the outlet, use different outlets for this unit and the device.

### ❑ The message "Noise Error" appears during AccuEQ Room Calibration

- This can be caused by a malfunction in your speaker unit. Check the speaker output, etc.

### ❑ The measurement results of AccuEQ Room Calibration show different distances to the speakers from the actual ones

- Depending on the speakers you are using, some errors may occur in the measurement results. If this is the case, make the settings in "2. Speaker" - "Distance" in the Setup menu.

( →p72)

### ❑ The measurement results of AccuEQ Room Calibration show that the volume level of the subwoofer has been corrected to the lower limit

- The volume level correction of the subwoofer may not have been completed. Lower the volume of the subwoofer before AccuEQ Room Calibration measurement.

### ❑ The POWER OUT jack cannot supply power to smart phones/tablets or other devices

- The POWER OUT jack on the rear panel is only intended to supply power (5 V/1 A) to the Streaming media player connected to HDMI IN jack of this unit with a USB cable. It cannot supply power to smart phones/tablets or other devices.

## About HDMI

### Compatible functions

HDMI (High Definition Multimedia Interface) is a digital interface standard for connecting TVs, projectors, Blu-ray Disc/DVD players, digital tuners, and other video components. Several separate video and audio cables have been required to connect AV components so far. With HDMI, a single cable can transmit control signals, digital video and digital audio (2-channel PCM, multichannel digital audio, and multichannel PCM).

HDMI CEC function:

By connecting a device that complies with CEC (Consumer Electronics Control) of the HDMI standard using an HDMI cable, a variety of linked operations between devices are possible. This function enables various linking operations with players, such as switching input selectors interlocking with a player, adjusting the volume of this unit using the remote controller of a TV, and automatically switching this unit to standby when the TV is turned off. The unit is designed to link with products that comply with the CEC standard, however, linked operation is not always guaranteed with all CEC devices. For linked functions to work properly, do not connect CEC-compliant devices exceeding the connectable number to the HDMI jack as shown below.

- Blu-ray Disc/DVD players: up to 3 units
- Blu-ray Disc/DVD recorders: up to 3 units
- Cable TV tuner, terrestrial digital tuner, and satellite broadcasting tuner: up to 4 units

Operation has been confirmed on the following devices: (As of January 2019) Toshiba brand televisions; Sharp brand televisions; Onkyo and Integra brand RIHD-compatible players; Toshiba brand players and recorders; Sharp brand players and recorders (when used with a Sharp brand television)

ARC (Audio Return Channel):

By connecting an ARC-compliant TV with a single HDMI cable, you can output the audio and video from this unit to the TV, and also input the audio from the TV to this unit.

HDMI Standby Through:

Even if this unit is in standby mode, the input signals from AV components can be transmitted to the TV.

3D:

You can transmit 3D video signals from AV components to the TV.

4K:

This unit supports 4K (3840×2160p) and 4K SMPTE (4096×2160p) video signals.

Lip Sync:

This setting automatically corrects desynchronization between the video and audio signals based on the information from the HDMI Lip Sync-compatible TV.

Copyright Protection:

The HDMI jack of this unit conforms to the Revision 1.4 and Revision 2.2 standards of the HDCP (High-bandwidth Digital Content Protection), a copy protection system for digital video signals. Other devices connected to the unit must also conform to the HDCP standards.

### Supported Audio Formats

2 ch linear PCM:

32 kHz, 44.1 kHz, 48 kHz, 88.2 kHz, 96 kHz, 176.4 kHz, 192 kHz, 16/20/24 bit

Multi-channel linear PCM:

Maximum 7.1 channels, 32 kHz, 44.1 kHz, 48 kHz, 88.2 kHz, 96 kHz, 176.4 kHz, 192 kHz, 16/20/24 bit

Bitstream:

Dolby Atmos, Dolby Digital, Dolby Digital Plus, Dolby TrueHD, DTS, DTS:X, DTS-HD High Resolution Audio, DTS-HD Master Audio, DTS 96/24, DTS-ES, DTS Express

DSD:

Supported sampling rates: 2.8 MHz

Your Blu-ray Disc/DVD player must also support the HDMI output of the above audio formats.

## Supported resolutions

HDMI IN1 to IN4:

- Copyright protection technology: HDCP1.4/HDCP2.2
- Color space (Color Depth):
  - 720×480i 60 Hz, 720×576i 50 Hz, 720×480p 60 Hz, 720×576p 50 Hz, 1920×1080i 50/60 Hz, 1280×720p 24/25/30/50/60 Hz, 1680×720p 24/25/30/50/60 Hz, 1920×1080p 24/25/30/50/60 Hz, 2560×1080p 24/25/30/50/60 Hz, 4K (3840×2160p) 24/25/30 Hz, 4K SMPTE (4096×2160p) 24/25/30 Hz : RGB/YCbCr4:4:4 (8/10/12 bit), YCbCr4:2:2 (12 bit)
  - 4K (3840×2160p) 50/60 Hz, 4K SMPTE (4096×2160p) 50/60 Hz : RGB/YCbCr4:4:4 (8 bit), YCbCr4:2:2 (12 bit), YCbCr4:2:0 (8/10/12 bit)

## General Specifications

### ■ Amplifier Section

#### Rated Output Power (IEC)

5 ch × 135 W at 6 ohms, 1 kHz, 1 ch driven of 1% THD

#### Maximum Effective Output Power (IEC)

5 ch × 155 W at 6 ohms, 1 kHz, 1 ch driven of 10% THD

#### Dynamic Power (\*)

\* IEC60268-Short-term maximum output power

160 W (3 Ω, Front)

125 W (4 Ω, Front)

85 W (8 Ω, Front)

#### THD+N (Total Harmonic Distortion+Noise)

0.08% (20 Hz - 20,000 Hz, half power)

#### Input Sensitivity and Impedance

200 mV/47 kΩ (LINE (RCA))

#### Rated RCA Output Level and Impedance

1 V/470 Ω (SUBWOOFER PRE OUT)

1 V/2.3 kΩ (ZONE B LINE OUT)

#### Frequency Response

10 Hz - 100 kHz/+1 dB, -3 dB (Direct)

#### Tone Control Characteristics

±10 dB, 20 Hz (BASS)

±10 dB, 20 kHz (TREBLE)

#### Signal to Noise Ratio

109 dB (IHF-A, LINE IN, SP OUT)

#### Speaker Impedance

4 Ω - 16 Ω

#### Headphone Rated Output

80 mW + 80 mW (32 Ω, 1 kHz, 10% THD)

#### Supported impedance of Headphones

8 Ω - 600 Ω

#### Headphones Frequency Response

10 Hz - 100 kHz

### ■ Tuner Section

#### FM Tuning Frequency Range

87.5 MHz - 108.0 MHz, RDS

#### 50 dB quieting sensitivity (FM MONO)

1.0 μV, 11.2 dBf (IHF, 1 kHz, 100% MOD)

#### DAB Tuning Frequency Range

174.928 MHz - 239.200 MHz (Band III)

#### DAB Sensitivity

-100 dBm (Min.) (Band III)

#### Preset Channel

40

### ■ BLUETOOTH Section

#### Communication system

BLUETOOTH Specification version 4.2

#### Frequency band

2.4 GHz band

#### Modulation method

FHSS (Freq Hopping Spread Spectrum)

#### Compatible BLUETOOTH profiles

A2DP 1.3

AVRCP 1.5

HFP(Hands-Free Profile) 1.6

HSP(Headset Profile) 1.2

SPP(Serial Port Profile) 1.2

#### Supported Codecs

SBC

AAC

#### Transmission range (A2DP)

20 Hz - 20 kHz (Sampling frequency 44.1 kHz)

#### Maximum communication range

Line of sight approx. 15 m (\*)

\* The actual range will vary depending on factors such as obstacles between

devices, magnetic fields around a microwave oven, static electricity, cordless phone, reception sensitivity, antenna's performance, operating system, software application, etc.

## ■ General

### Power Supply

AC 220 - 240 V, 50/60 Hz

### Power Consumption

465 W

0.2 W (Full Standby mode)

0.2 W (HDMI CEC)

34.2 W (No-sound)

24.4 W (HDMI Standby Through)

### Dimensions (W × H × D)

435 mm × 160 mm × 328 mm

17-1/8" × 6-5/16" × 12-15/16"

### Weight

8.2 kg (18.1 lbs.)

### Maximum radio-frequency power transmitted in the frequency band(s)

2402 MHz - 2480 MHz (4 dBm (e.i.r.p))

## ■ HDMI

### Input

IN1 (BD/DVD), IN2 (GAME), IN3 (CBL/SAT), IN4 (STRM BOX)

### Output

OUT

### Supported

Audio Return Channel, 3D, 4K 60 Hz, 6G, HDR10, BT.2020, HLG, Dolby Vision, Auto Lip Sync, CEC

### Audio Format

Dolby Atmos, Dolby TrueHD, Dolby Digital, Dolby Digital Plus, DTS, DTS:X, DTS-HD Master Audio, DTS-HD High Resolution Audio, DTS 96/24, DTS-ES, DTS Express, DSD (PCM Conversion Input), 2-channel linear PCM, Multi-channel linear PCM

### HDCP version

2.2

### Maximum Video Resolution

4K 60 Hz (YCbCr 4:4:4)

## ■ Supported input resolutions

### HDMI input

4K, 1080p/24, 1080p, 1080i, 720p, 480p/576p

- Signals are output from the HDMI OUT jack of this unit to the TV with the same resolution as the input resolution. When using a TV that supports 4K, 1080p HDMI video signals can also be output as 4K.

## ■ Audio Inputs

### Digital

OPTICAL (TV)

COAXIAL (CD)

### Analog

CD, AUX, PC

## ■ Audio Outputs

### Analog

ZONE B LINE OUT

2 SUBWOOFER PRE OUT

### Speaker Outputs

FRONT L/R, CENTER, SURROUND L/R

### Phones

PHONES (Front, ø 6.3 mm, 1/4")

## ■ Others

Setup Mic: 1 (Front)

USB: 1 (Only for supplying power to Streaming media player, 5 V/1.0 A)

Specifications and features are subject to change without notice.

## ☐ → [License and Trademark](#)



**ONKYO**

SN 29403896\_EN

(C) Copyright 2019 Onkyo & Pioneer Corporation Japan. All rights reserved.

H1910-0