

Kamome FKLS-302D

User's Manual

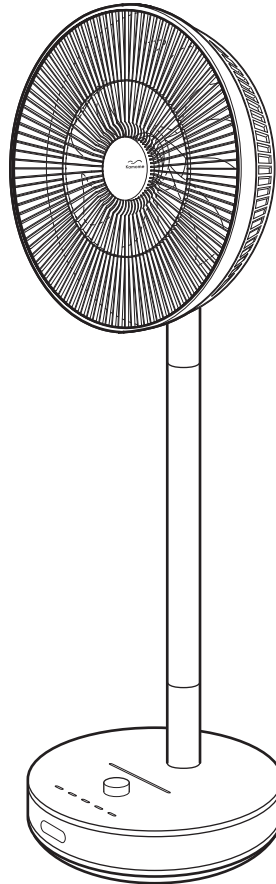

Thank you for purchasing the Kamome FKLS-302D. Be sure to carefully read this manual to ensure that you use this product correctly. After reading this manual, keep it in a safe place for future reference.

*This product is designed to be assembled by customers themselves.

Safety Information

Before use, be sure to carefully read this manual on safety to ensure that you use this product correctly. Always follow these instructions when using the product.

WARNING

In order to avoid any electrical shock, short-circuit, burns, or cause a fire:

- Do not disassemble. This product may only be disassembled by qualified repair technicians. To request repair, see Warranty Page at the back of this manual.
- Do not use if the power cord or plug is damaged, or if the plug is not fully inserted into the outlet.
- Do not scratch, damage, modify, forcibly bend, pull, twist, bind/clamp, or place heavy objects on the power cord.
- Do not insert metal objects, such as pins, wires, or other foreign materials into any gaps of the product.
- Do not allow children to use this product by themselves, and keep product and power cords out of the reach of small children.
- Use only with the designated power supply 220 – 240 V.
- If you notice anything unusual during operation (burning smell, smoke, etc.), immediately stop use, and unplug the power cord.

Insert the power plug all the way into the outlet. Use an outlet with no other devices plugged in.

Wipe off any dust adhering to the power plug blades and plug surface.

If any liquid leaks from the battery of the remote control and gets in your eyes, do not rub them; rinse them out with water and see a doctor.

When cleaning the product, for safety's sake be sure to unplug it from the outlet. Do not plug or unplug the product while your hands are wet.

Never use in a location that produces flammable or corrosive gases, or where they accumulate.

Always allow the unit to cool down before picking it up for service or storage.

Do not use close to walls or furniture.

Do not use in unstable locations or on flooring that may be easily damaged by heat.

Do not use for other purposes, such as drying things. Do not put clothing or laundry on or over the fan.

When cleaning the product, do not use household detergent, thinner, benzene, alcohol or a polishing powder or spray.

English

For remote control batteries, do not use any other than specified.

Do not leave the battery of the remote control in a hot location or in direct sunlight.

When unplugging the power cord, always unplug by grasping the power plug, not by pulling on the power cord.

Face the terminals +/- correctly when putting the battery in the remote control.

Remove the battery from the remote control when it will not be used for a long time.

Do not touch areas that get extremely hot, such as the heat grille, the top panel and the back of the unit while in use and for some time afterwards.

Name and Function of Each Part

Front

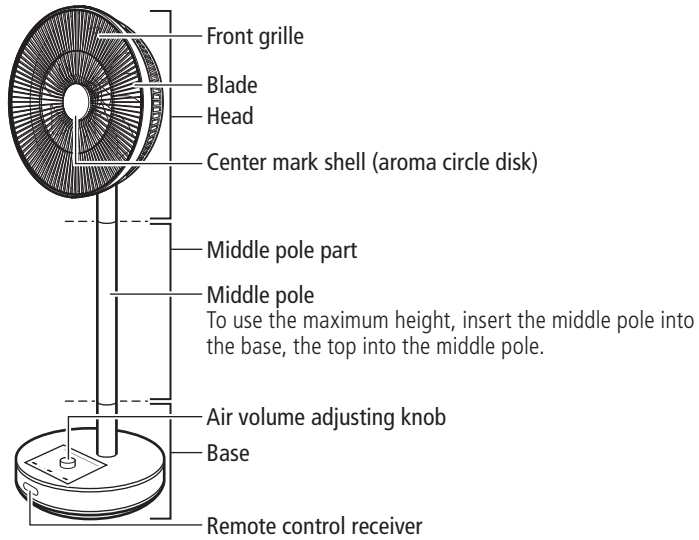

Rear

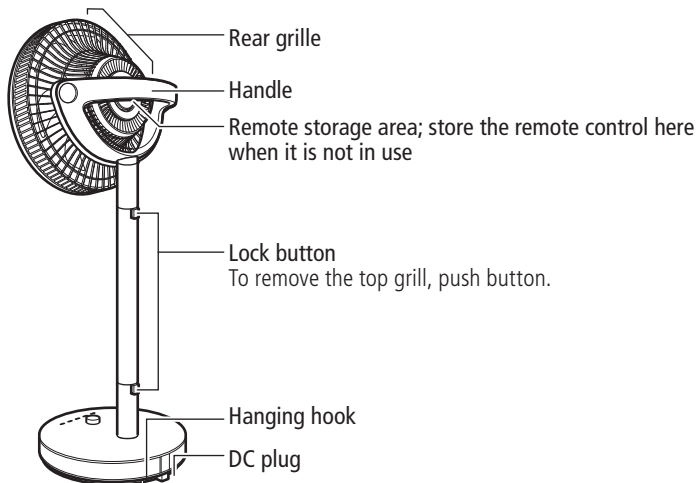

AC adapter

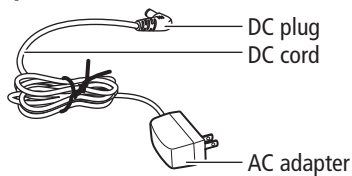

Control panel of main unit

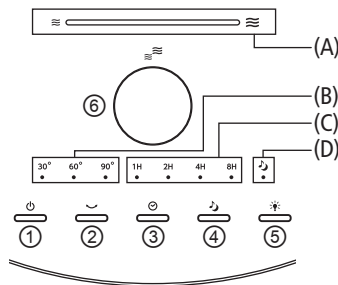

Remote control

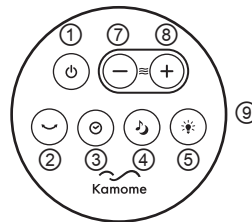

- (A) **Air volume light**
Indicates the air volume; when the air volume increases, the light turns on from left to right
- (B) **Swing light**
The light turns on when swing function is enabled.
- (C) **Timer light**
Schedule on timer is green and the schedule off timer is red.
- (D) **Natural/sleep wind light**
The white light turns on in natural wind mode and the blue light turns on in sleep wind mode.
- ① **Power button**
Start/stop running.
- ② **Swing button**
Start/stop swing.
- ③ **Timer button**
Set the time for schedule power on/off.
- ④ **Natural/sleep wind button**
Switch between natural wind and sleep wind.
- ⑤ **Dimmer button**
Enable or disable dimmer mode.
- ⑥ **Air volume adjusting knob**
Adjust the air volume while unit is on.
- ⑦ **Air volume - button (remote control)**
Reduce the air volume while unit is on.
- ⑧ **Air volume + button (remote control)**
Increase the air volume while unit is on.
- ⑨ **Signal receiver (remote control)**
Point the remote control at the signal receiver.

Accessories included in box

Main unit.....	1
Middle pole	1
Dedicated AC adapter.....	1
Remote Control	1
Coin lithium battery.....	1
Replacement felt (1 in aroma circle disk).....	4
Manual (including Warranty Card).....	1

Installation and Setup

Attention

Turn on the power only when the blades and guards have been properly installed.

1. Assembly of base, middle pole and head

The middle pole can be removed or installed, and the height can be adjusted.

Enlarged View of Connection

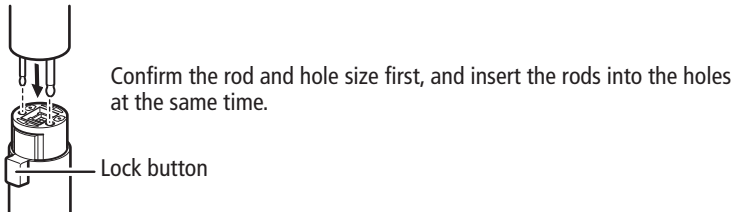

The height is about 100 cm when the product is extended.

- ① Put the base on a stable position.
- ② Insert the middle pole into the base.
- ③ Insert the head into the middle pole.

Rear

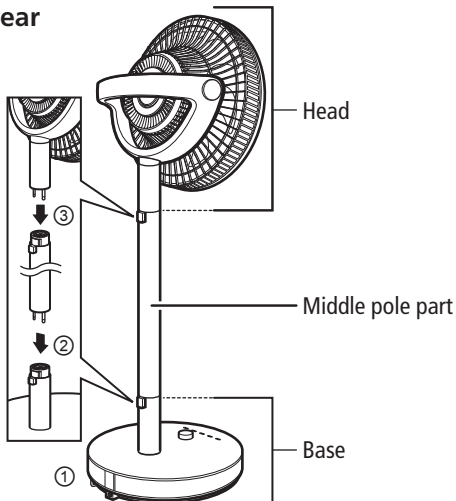

The height is about 57 cm when the middle pole is not used.

① Put the base on a stable position.

* Press the lock button to remove the head and middle pole.

Rear

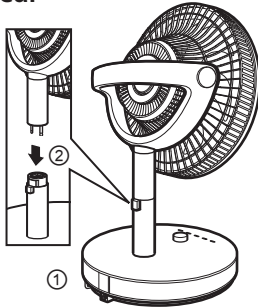

Attention

There should be no gaps between the connected parts.

If the installation is not connected properly, the fan may shake or dislodge.

2. Put the main unit on a stable level place
 - Hold the handle to pick up and move the main unit.
3. Use a dedicated AC adapter

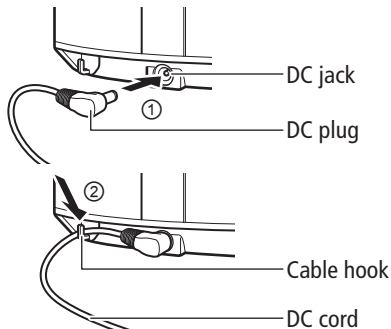

① Please insert the DC plug of the AC adapter is into the DC jack on the back of the base.

② In order to avoid tripping over the cord, hook it to the base.

4. Install the battery into the remote control

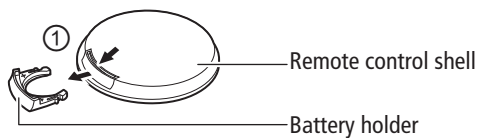

① Pull out the battery holder from the remote control.



② Insert the coin lithium battery into the battery holder.
Pay attention to the polarity of the battery.

③ Re-Insert the battery holder into the remote control until you hear a click sound.

Attention

- Remove the battery when it is not used for a long time.
- The positive and negative terminals of the battery must be installed correctly.
- When liquid leakage occurs, clean it completely before inserting a new battery.

When the remote control is not in use

Please place the remote control in the storage area behind the grille.

The remote control will adhere to the magnet.

Attention

Do not place the remote control in chest pocket if you are using a cardiac pacemaker.

Range

- About 5 m in front of the main unit.
- About 30° to the left and right sides in front of the main unit.
- If there is an obstacle between the remote control and the main unit, the remote control may not work properly.

5. When the DC plug is inserted into the power outlet, the product emits a sound.

Correct Use of the Fan

Start/stop operation

1. Start operation



Simply press the  power button on the main unit or remote control to start the operation.

- In normal use, the air volume and swing angle will default to the setting when it was turned off last time because of the memory function.

* When the AC adapter is removed from the plug, the device will automatically restore the initial settings.

[Initial setting] Air volume: Minimum; Swing: None.

2. Adjustment of air volume

When the fan is on, you can turn the air volume knob on unit to the right or press  on the remote control to increase the air volume. Press the knob to the left or press  on the remote control to reduce the air volume.

Air volume light band

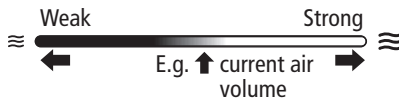

Control panel of main unit

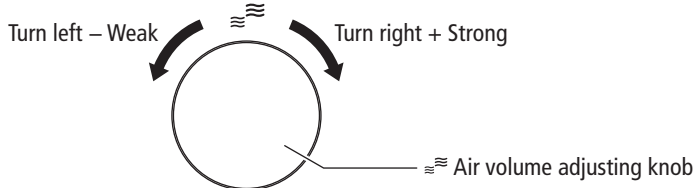

Remote control

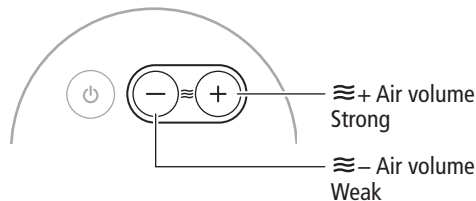



3. Start natural /sleep wind function

Press  the natural/sleep wind button on the main unit or the remote control during operation to switch functions.

About natural wind/sleep wind



Natural wind (white LED turns on)

Both high level and low level can reproduce natural wind.

Press the  and the  button on the unit or the remote control to adjust the air volume.

Sleep wind (blue LED turns on)

Both high level and low level can reproduce natural wind.

Press the  and the  button on the unit or the remote control to adjust the air volume.

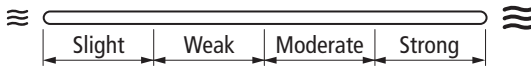

Strong wind Strong → Moderate → Weak → Slight, change with time

Moderate wind Moderate → Weak → Slight, change with time

Weak wind Weak → Slight, change with time

Slight wind Slight, same with natural wind

* Air volume light band still displays as set.

4. Start/stop swing

The left/right swing angle of the fan can be set to 30°, 60° or 90°.

- When you plug the AC adapter into the outlet and press the <swing> button on the main unit or the remote control, the 30° LED turns on and the fan start swing.

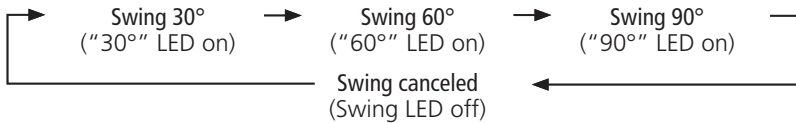

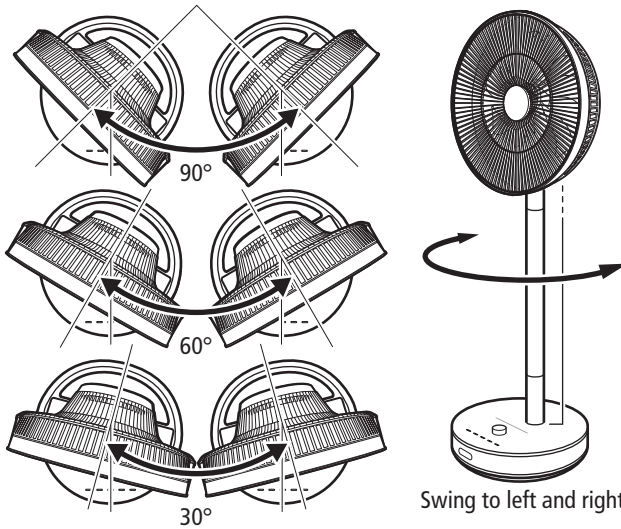

The swing angle can be manually adjusted by 70° upwards, 10° downwards and 60° horizontally.

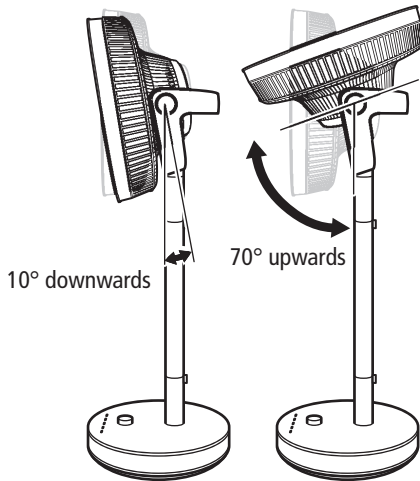



5. Enabling/disabling dimmer mode

If the air volume light band or LED light is too bright, you can press the Dimmer button on the unit or the remote control to dim the light; press it again to cancel dimmer function.

Timer Setting - Off timer

You can set the off timer and the fan stops automatically after the set time.

1. When the fan is running, you can press the timer button  to set the off timer, and the red LED light will turn on.

Press the  button on the unit or remote control to set the time of schedule operation.

2. To cancel the timer, press the  button on the unit or remote control and the timer LED light will turn off.

Timer Setting - On timer

You can set the on timer and the fan starts automatically at the set time.

1. When the fan is off, you can press the timer button  to set the on timer and the green LED turns on.
 - The product integrates memory function, and the air volume LED and swing LED of last mode will flash. The time of on timer displays in the on timer setting menu.

About timer LED

Timer LED

When you press the  Timer button on the unit or the remote control, the timer LED changes as follows.

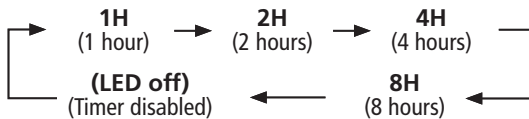

After setting the off/on timer, the LED changes with time. the timer shows the time when the operation stops.

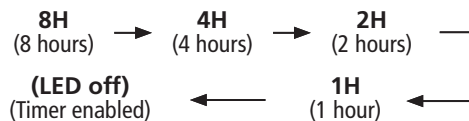

The LED is red when the off timer is enabled and green when the on timer is enabled.

Off timer and on timer can't be enabled at the same time.

Use of aroma oil

1. Remove the center mark shell (aroma circle disk) from the center of front grille, turn the center mark shell to the left to unfasten it.
2. Make sure that the felt tab is installed. Carefully sprinkle 2-3 drops of aromatic or natural essential oil onto the felt tab.

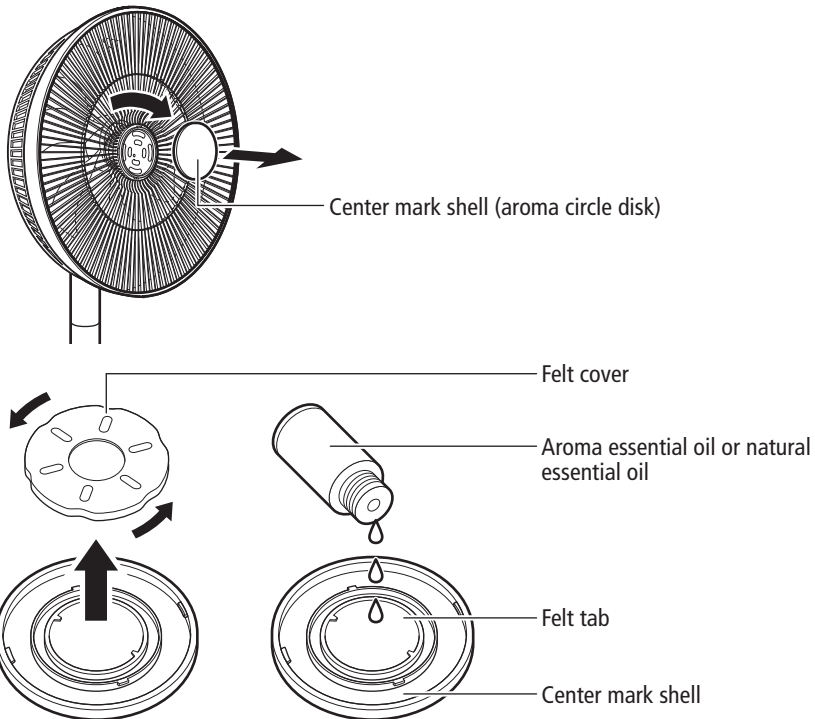

3. Install the felt cover, and put the aroma circle disk back into place. When installing the felt cover, place it in the center mark shell and turn to right. Then put the center mark shell back on the front grille and turn to right.

Felt tab replacement

- * If the aroma oil felt tab is dirty or a different aroma oil is used, replace the felt tab.
- * To replace the felt tab, turn the felt cover to left, and then take out the felt tab.
- * In addition to the felt tab inside the disk we also provide 3 replacement felt tabs.
- * Clean the center mark shell with neutral detergent, fully dry and install according to steps 1 to 3.

Felt tab replacements are sold separately.
Please contact the service department.

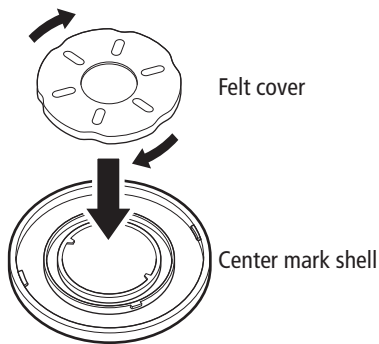

Cleaning and Storage

WARNING

Disconnect the plug from the power outlet before maintenance.

Storage

When the product is not in use, use warm water or neutral detergent. Then gently wipe away any stains on the product. Then wipe with a dry cloth.

Disassembly of blades

Remove the front grille before removing the blades. It is best to operate with two persons at the same time. One person holds the product and the other removes the grille.

Attention

Do not insert the power plug into the outlet until the blades and grille are secure.

Disassembly of the blades/front grille

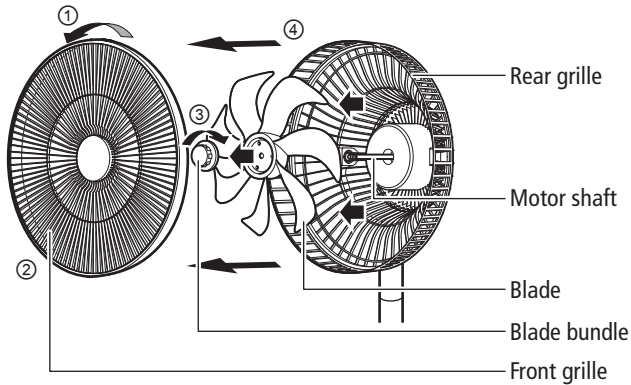

1. To remove the front grille and turn the front grille to the left. See ①.

Attention

Do not turn the front grille excessively in the opposite direction. This may cause product damage or malfunction.

2. Hold the blades with your left hand, turn the blade bundle with your right hand, remove the blade bundle and then remove the blades.

The structure of the blade bundle is different from that of the ordinary rotating components.

Contra to ordinary rotating direction, rotation to the left is to tighten and rotation to the right is to disassemble.

- * Rear grille can't be disassembled as there are lines inside.
- * Please be sure to store in a dry environment.

Assembly of the blades/front grille

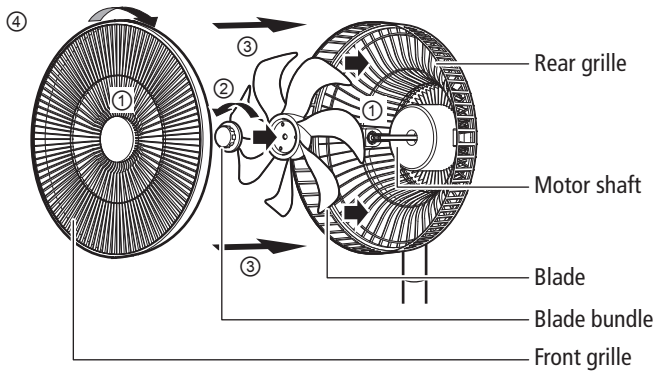

1. Align the blade to the motor shaft and install it. See Fig. ①.

Align the center of the blade with the center of the motor shaft and insert the blade into the root of the motor shaft.

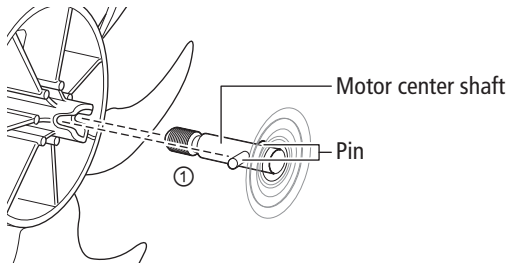

When the blades are assembled, align the blade center with the center of the motor shaft, and insert the blade into the motor shaft center. See Fig. ①.

2. Hold the blade with your left hand, and align the blade center with the motor shaft and turn to the left with right hand to fix the blade. See Fig. ②.

3. Align the recess of front grille with the U-shaped print on rear grille.

Fasten the front grille to the rear grille. See Fig. ③.

4. Rotate the front grille to the right. See Fig. ④.

Turn the front grille to the right until it is locked.

There will be abnormal noise if the front grille is not locked.

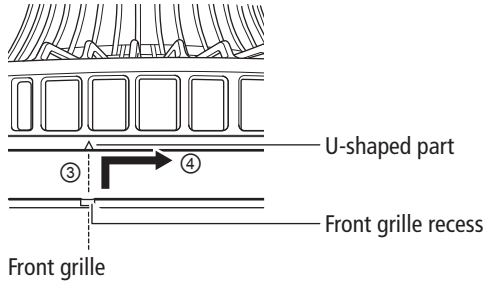

Align the recess of front grille with the U-shaped part of rear grille, and fasten the front grille ③; turn to the right ④.

Storage method

- After disassembling, please clean and dry the parts.
- Put the dried parts in a plastic bag and put it in the packing box.
- Before packing, adjust the head to the front.
- When it is not in use for a long time, take out the battery of the remote control.

Troubleshooting

Please check if the product has any of the following symptoms before sending it for repair.

Problem	Cause	Solution
Blades won't turn.	<ul style="list-style-type: none"> The blades are not correctly installed. The blades are stuck. 	Install blades and grilles properly as described on page 18 "Assembly of the blades/front grille".
	The fan/middle pole/base are not installed properly.	Refer to pages 7-8 and reinstall fan/middle pole/base properly.
	DC plug disconnected from the DC jack.	Plug DC connector firmly into the DC jack (page 8).
	Power plug disconnected from the outlet.	Reinsert the power plug (page 8).
Operation stops suddenly.	Unit is turned off for 12 hours and the auto-off function is activated (pages 10-12).	Press the power button on the main unit or remote control to turn on the power.
Air volume light band or indicators are dark.	Dimmer mode is set.	Cancel dimmer mode (page 12)
Loud noise when fan is on.	<ul style="list-style-type: none"> The blades are installed incorrectly. The blades are stuck. The grille isn't installed properly. 	Install blades and grilles properly as described on page 18 "Assembly of the blades/front grille".
	Blade is loose.	Tighten the bundle as described on page 18 "Assembly of the blades/front grille".
The swing angle is greater than set or normal operation starts after a certain period when the swing button is pressed.	<ul style="list-style-type: none"> This is not a defect. The unit first turns to the left for 45° from the stop position and then turns to the center to start. 	Please wait for the swing to resume normal.
Remote operation invalid.	The battery voltage is low.	Replace the battery (page 9).
	The battery is installed incorrectly.	Install the battery properly (page 9).
	<ul style="list-style-type: none"> The remote control doesn't point at the receiver. Too far away from the receiver. 	Point at the receiver Operate in effective range (page 9).

The fan needs to be checked regularly for any defects.

- Power cord, plug or AC adapter heats up abnormally.
- The power connects and then disconnects repeatedly.
- Buring smell.



Please turn off the power, unplug the power cord and contact the service department at Doshisha.

Specifications

Product name	Kamome
Model	FKLS-302D
Power supply	220 – 240 V. 50/60 Hz - (DC 24 V)
Power consumption	20 W
AC adapter cord length	Approx. 2.5 m
Size	Width 34 cm × Length 28.5 cm × Height 57 cm (L) Height 100 cm (H)
Weight	Approx. 4 kg. (body only)
Accessories	User's Manual / Warranty × 1, AC adapter × 1, Remote controller × 1, Coin type lithium battery × 1, Felt tabs × 4

* Due to a continuous process of product improvement, the specifications and other information are subject to change without notice.



Imported and distributed by



XXXXX

